

INCANTO S-CLASS

from page 03 to page 110

INCANTO rondo

INCANTO classic

INCANTO de luxe

INCANTO sirius

Revision: 1

INCANTO

from page 111 to page 196

INCANTO easy

INCANTO

INCANTO rapidsteam

INCANTO digital

INCANTO digital SBS

Revision: 5

SERVICE MANUAL

Saeco

Saeco International Group

All parts of the present service manual are the property of Saeco International Group. All rights reserved. The manufacturer is not responsible for any errors or omissions in the present document. Any reproduction or unauthorized use of this manual without the prior written permission of the manufacturer or by contractual agreement is prohibited.

INCANTO S-CLASS

INCANTO rondo
INCANTO classic
INCANTO de luxe
INCANTO sirius

SERVICE MANUAL

Revision: 1

Saeco

Saeco International Group

FEB.: 2005

All parts of the present service manual are the property of Saeco International Group. All rights reserved. The manufacturer is not responsible for any errors or omissions in the present document. Any reproduction or unauthorised use of this manual without the prior written permission of the manufacturer or by contractual agreement is prohibited.

Table of contents

- 1. Introduction**
- 2. Technical data**
- 3. Operation**
- 4. Functions and timing**
- 5. Service programme**
- 6. Faults**
- 7. Repairs / Service Schedule / Final Test**
- 8. Disassembly**
- 9. Circuit diagrams**

CHAPTER 1

INTRODUCTION

	Page
1. Documents required	1
2. Equipment	1
3. Material	1
4. Safety instructions	1
5. Overview of product range	2

1. Requirements for operation

- Service manual
- Operating instructions where available

2. Equipment

In addition to an electrical workshop, the following standard tools are necessary:

Qty	Description	Comments
1	Special screwdriver (Pozi)	Size: PZ1
1	Special screwdriver (Pozi)	Size: PZ2
1	Temperature measuring device	Temperature range > 200°C Suitable for point measurements

3. Material

Description	Comments	Brand
Heat conductive paste	Temperature resistance $\geq 200^\circ$	User's choice
Bolt adhesive	Temperature resistance $\geq 200^\circ$ (medium strength disassemblable)	User's choice
Descaler		Saeco
Grease solvent		User's choice
Silicone grease (food safe)		Saeco
Grease for grinder gear !		Saeco

4. Safety instructions

All prescriptions and regulations in force regarding the repair of electrical equipment must be observed!

The machine must be disconnected from the main power supply before performing repair work. Switching the machine off is not an adequate measure.

The Incanto coffee machine is classified under Protection Class 1. Protective devices must be tested once the repair work has been completed (HG 701).

5. Overview of product range (Incanto S-CLASS)



Incanto rondo



Incanto classic



Incanto de luxe



Incanto sirius

	Pre-brewing	Rapid steam	Powder coffee compartment	Cup warmer	Display	SBS
INCANTO rondo black	X					
INCANTO rondo SBS	X					X
INCANTO classic	X	X	X	X		X
INCANTO de luxe	X	X	X	X	X	X
INCANTO sirius	X	X	X	X	X	X

CHAPTER 2

TECHNICAL DATA

	Page
1. Technical data (Incanto rondo)	1
2. Technical data (Incanto classic) (Incanto de luxe) (Incanto sirius)	2

1. Technical data (Incanto rondo)

INCANTO rondo	
Technical data	
Power supply/output:	230V 50Hz 1250W
Safety system:	170°C Safety thermostat for instantaneous water heater
Temperature monitoring:	PTC - KTY Temperature sensors transmit respective temperatures to electronic system
Heating system:	Instantaneous water heater (1090 W) for coffee, hot water and steam dispensing.
Pump:	Ulka reciprocating piston pump, 230V, 50 Hz, 48 W, Type EX5, 20 l/h, approx. 15 bar
Safety valve:	Defibration safety valve (17 bar) connected directly to pump.
Water filter:	In water tank, installed at outlet.
Gearmotor:	Direct current, 30 - 35 V
Gear resistor:	Approx. 437W / 130Ω on instantaneous water heater
Cup warmer:	-
Grinder:	Flat milled grinder (ceramic discs)
Grinder motor:	230V Direct current
Second doser:	Pulse control (approx. 6-12g)
Power consumption:	During heating - approx. 4.5 A
Pump pressure:	Max. 15 bar
Dimensions W x D x H in mm:	285/400/375
Weight:	Approx. 9kg
Capacity of coffee bean container:	Approx. 300g
Capacity of water tank:	Approx. 1.7l max.
Boiler capacity:	Approx. 1.0 ccm, 10 ml volume
De-aeration time:	Approx. 10 for initial start-up
Heating time:	About 45 sec.
Steam heating time:	About 25 sec.
Coffee dispensing temperature:	Approx. 86° C
Grinding time:	8 sec. /10g
Time to make espresso:	Approx. 28 sec. for 50 ml
Time to make cup of coffee:	Approx. 40 sec. for 100 ml

2. Technical data (Incanto classic, de luxe, sirius)

INCANTO classic, de luxe, sirius	
Technical data	
Power supply/output:	230V 50Hz 1250W
Safety system:	170°C Safety thermostat for instantaneous water heater
Temperature monitoring:	PTC - KTY Temperature sensors transmit respective temperatures to electronic system
Heating system:	Instantaneous water heater (1090 W) for coffee and hot water dispensing. Pipe heating (1090 W) for steam dispensing
Pump:	Ulka reciprocating piston pump, 230V, 50 Hz, 48 W, Type EX5, 20 l/h, approx. 15 bar
Safety valve:	Defibration safety valve (17 bar) connected directly to pump.
Water filter:	In water tank, installed at outlet.
Gearmotor:	Direct current, 30 - 35 V
Gear resistor:	Approx. 437W / 130Ω on instantaneous water heater
Cup warmer:	Foil heating (approx. 8 W / 6.3 KΩ at room temperature)
Grinder:	Flat milled grinder (ceramic discs)
Grinder motor:	230V Direct current
Second doser:	Pulse control (approx. 6-12g)
Power consumption:	During heating - approx. 4.5 A
Pump pressure:	Max. 15 bar
Dimensions W x D x H in mm:	285/400/375
Weight:	Approx. 10kg
Capacity of coffee bean container:	Approx. 300g
Capacity of water tank:	Approx. 1.7l max.
Boiler capacity:	Approx. 1.0 ccm, 10 ml volume
De-aeration time:	Approx. 10 for initial start-up
Heating time:	About 45 sec.
Steam heating time:	About 25 sec.
Coffee dispensing temperature:	Approx. 86° C
Grinding time:	8 sec. /10g
Time to make espresso:	Approx. 28 sec. for 50 ml
Time to make cup of coffee:	Approx. 40 sec. for 100 ml

CHAPTER 3

OPERATION

	Page
1. Operation (Incanto rondo)	
1.1. Control panel	1
1.2. Operating instructions	2
2. Operation (Incanto classic)	
2.1. Control panel	4
2.2. Operating instructions	5
2.3. User programme	8
3. Operation (Incanto de luxe)	
3.1. Control panel	9
3.2. Operating instructions	10
3.3. User programme	14
4. Operation (Incanto sirius)	
4.1. Control panel	16
4.2. Operating instructions	16
4.3. User programme	20

1. Operation (Incanto rondo)



1.1. Control panel

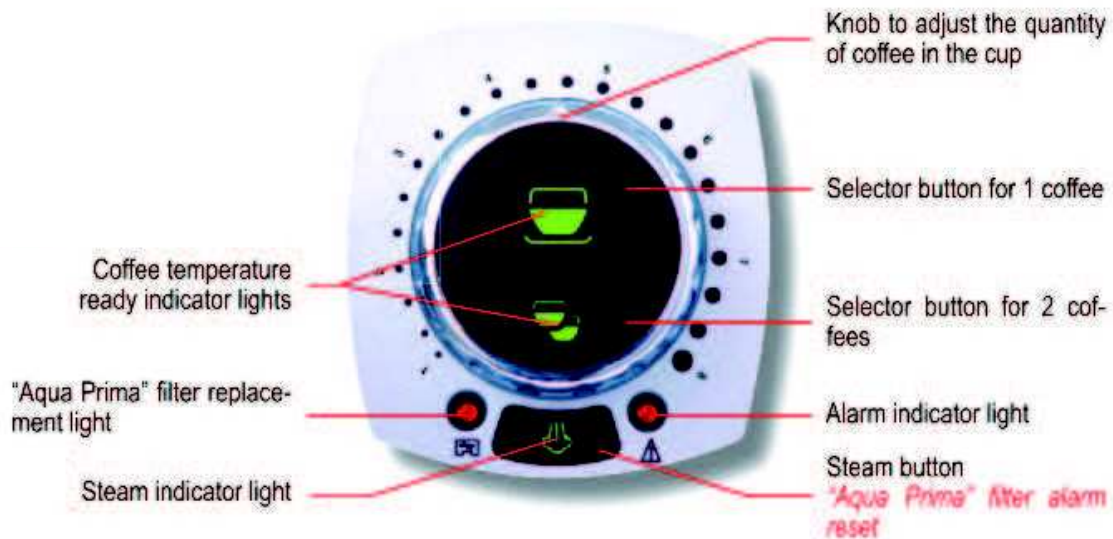

1.2. Operating instructions (quick reference)

	Action	Comments	LED 1 Coffee	LED 2 Coffee	Steam LED
Getting started					
1	Unpack machine.	Check for damage.			
2	Install Aqua Prima filter.				
3	Fill water tank	Wait for 30 min.			
4	Fill coffee beans container.				
5	Connect mains plug.				
6	Turn on main switch.		Flashes	Flashes	
7	De-aerate water circuit.	Open hot water pressure valve until water flows.	Flashes	Flashes	
		Heating stage (approx. 45 sec.)	Flashes	Flashes	
		Ready	ON	ON	
Reset filter counter					
8	Press steam button.	Filter LED flashes briefly.			
Making coffee					
9	Pre-select cup fill volume with setting button.	Depending on cup size.	ON	ON	
10	Place cup under dispenser.				
11	Press start button (coffee button).	Button 1 Coffee	Flashes		
		Button 2 Coffee		Flashes	
Coffee dispensing / Powder coffee					
12	No powder dispensed				
Dispensing steam					
13	Press steam button.	Heating stage.			Flashes
14		Ready			ON
15	Steam dispensing. Open HWS valve	To warm coffee. To froth milk.			ON
16	Press steam button / deactivate steam function.	Cool by de-aerating.	Flashes	Flashes	Flashes
		Ready (to make coffee)	ON	ON	
Hot water dispensing					
17	Open HWS valve	Immediate	ON	ON	

Cleaning	
Empty dregs drawer	Storage capacity 12 tabs.
Empty drip tray	After 12 tabs.
Clean water tank	As required.
Clean coffee bean container	As required.
Clean the housing	As required.
Rinse brewing unit	1 x per week
Clean brewing unit and lubricate	1 x per month
Clean filter	
Descale	Depending on water hardness.

Descaling frequency			
Water hardness		Without Aqua Prima	With Aqua Prima
Very hard water (over 21°dH)		About every 4 weeks	About every 6 weeks
Hard water (15°-21°dH)		About every 6 weeks	About every 2 months
Medium water (15°-21°dH)		About every 2 months	About every 3 months
Soft water (4-7°dH)		About every 3 months	About every 6 months
Soft water (0-3°dH)		About every 6 months	About every 6 months
Descaling procedure			
Action		Comments	
1	Remove Aqua Prima filter from water tank.		
2	Fill water tank with descaler according to the relevant instructions (Saeco descaler).	Place an appropriately sized container under the HWS nozzle.	
3	Open HWS valve	Remove approx. 1/4 litre	
4	Turn machine off.	Allow descaler to act for 10 min.	
5	Turn machine on and repeat Points 3 to 5 until the descaler mixture is used up.		
6	Close HWS valve		
7	Fill tank with fresh water.	Open HWS valve	
8	Rinse (until tank is empty)	Descaling complete	
9	Re-install Aqua Prima filter in water tank / Fill tank.		
Troubleshooting			
Fault		Remedy	
No display No power supply to machine.		Check mains fuses / Is machine plugged in? / Is main switch turned on?	
Coffee is not hot enough		<ul style="list-style-type: none"> - Pre-heat cups - Clean brewing unit if necessary - Descale if necessary 	
No hot water/steam Hot water/steam nozzle blocked		<ul style="list-style-type: none"> - Clean nozzle out with needle (with machine turned off and closed rotary valve/HWS valve). 	
Heating time too long, water quantity insufficient		<ul style="list-style-type: none"> - Descale machine 	
The brewing unit cannot be removed.		<ul style="list-style-type: none"> - Close service door. - Turn machine on (brewing unit moves to home position) 	
Cannot dispense			
LED 1 Coffee, LED 2 Coffee and Steam LED flash		<ul style="list-style-type: none"> - Overheating: Remove hot water until only espresso and coffee buttons are lit. 	
Filter warning LED lights up (MACHINE NOT LOCKED)		<ul style="list-style-type: none"> - Install Aqua Prima filter. Reset: Press steam button until filter warning LED flashes 	
Warning LED lights up		<ul style="list-style-type: none"> - Fill water tank. - Fill coffee beans container. - Empty grinds container 	
Warning LED flashes		<ul style="list-style-type: none"> - Dregs drawer/drip tray not installed. - Brewing unit not installed. - Doors not closed. - Grinder obstructed. - Gears obstructed - Contact an authorised service centre. 	

2. Operation (Incanto classic)



2.1 Control panel

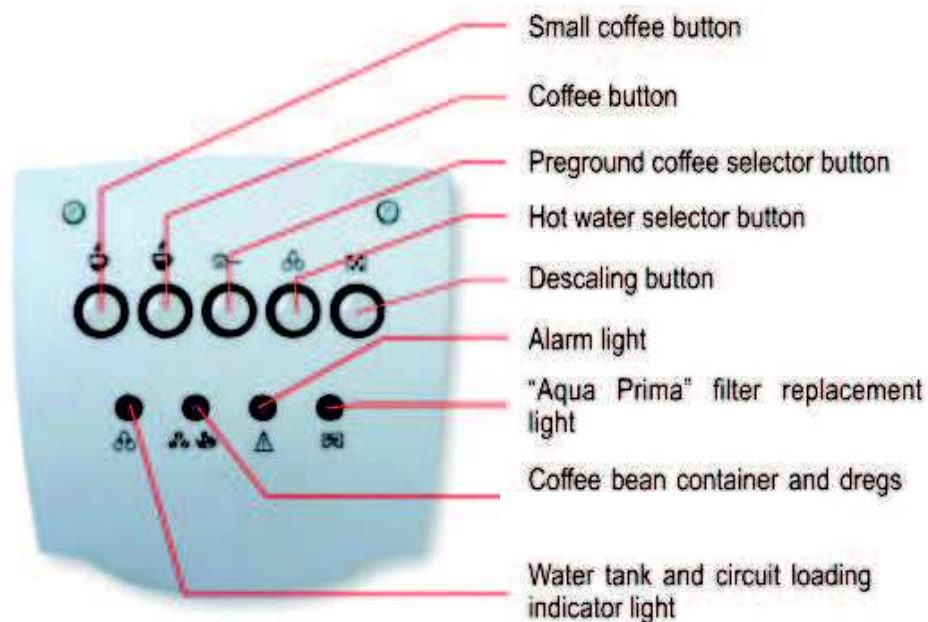

2.2. Operating instructions (quick reference)

	Action	Comments	Powder button LED	Espresso LED	Coffee LED	Hot water LED
Getting started						
1	Unpack machine.	Check for damage.				
2	Fill water tank					
3	Install Aqua Prima filter.	Wait for 30 min.				
4	Fill coffee beans container.					
5	Connect mains plug.					
6	Turn on main switch.			Light flashes	Light flashes	
7	De-aerate water circuit.	Press hot water button Open hot water pressure valve until water flows.		Light flashes	Light flashes	Light on
		Heating stage (approx. 1.5 min).		Light flashes	Light flashes	
		Ready		ON	ON	
Reset filter counter						
8	Press hot water button (about 6 sec.)	Filter LED flashes briefly.		ON	ON	
Making coffee						
9	Programme coffee quantity for each selection button. <ul style="list-style-type: none"> • Coffee • Espresso 	Depending on cup size. Programme by keeping the coffee selection button pressed until the desired quantity is reached.		Light flashes For espresso programming	Light flashes For coffee programming	
10	Press start button (coffee button).	Press once = 1 cup of coffee		Light flashes	(flashes)	
		Press twice = 2 cups of coffee.		Light flashes 2 x interval	(flashes) 2 x interval	
Coffee dispensing / Powder coffee						
11	Place cup under dispenser.	Place powder coffee in powder container (1 measuring spoonful)				
12	Select powder button and relevant coffee button: Espresso / Coffee	Only one coffee can be dispensed at a time.	ON	Light flashes	(flashes)	
Dispensing steam						
13	Open HWS valve	Immediately ready		ON	ON	

Hot water dispensing						
14	Press hot water button.	Immediately ready		ON	ON	ON
15	Open HWS valve	Water removed		ON	ON	ON
16	Close HWS valve	Water removal complete		ON	ON	ON
17	Press hot water button.	Steam mode		ON	ON	Off

Cleaning		
	Empty dregs drawer	Storage capacity of 12 tablespoons (Reset - empty only when indicated and with machine on)
	Empty drip tray	After 12 servings
	Clean water tank.	As required.
	Clean coffee bean container.	As required.
	Clean the housing.	As required.
	Rinse brewing unit	As required.
	Clean brewing unit and lubricate	1 x per month
	Clean filter	
	Descale	According to indicator.

Descaling frequency			
Water hardness		Without Aqua Prima	With Aqua Prima
Very hard water	(over 21°dH)	About 2 - 4 weeks	About 4 - 6 weeks
Hard water	(15°-21°dH)	About 4 - 6 weeks	About every 2 months
Medium water	(15°-21°dH)	About every 2 months	About every 3 months
Soft water	(4-7°dH)	About every 3 months	About every 6 months
Soft water	(0-3°dH)	About every 6 months	About every 6 months
Or when descaling requirement indicated.			

Descaling procedure			
Action	Comments	Descale LED indicator	
Need to descale	Remove the Aqua Prima filter from the tank.	Light flashes	
	Fill water tank with commercial descaler according to the relevant instructions (Saeko descaler recommended).	Light flashes	
	Place an appropriately sized container under the HWS nozzle.	Light flashes	
Keep the descaling button pressed for about 5 sec.	Descaling programme is activated.	ON	
Open HWS valve	The pipes are rinsed with descaler at intervals. (Duration: approx. 45 min)	ON	
Programme end	When flow meter takes in air.	LED of all 5 buttons flash	
Close HWS valve	Descaling programme complete.	Off	
Rinse (fill tank 2x)	Open HWS valve	Off	
Install Aqua Prima filter.		Off	

Troubleshooting		
Fault	Cause	Remedy
The machine does not switch on.	The machine is not connected to the mains power supply.	Turn on main switch.
		Check plug and connection.
The coffee is not hot enough.	The cups are cold.	Pre-heat cups.
	A low temperature has been set.	Set the machine to a higher temperature.
Only hot water is dispensed when powder coffee is selected.	No powder coffee has been filled.	Fill powder coffee and start once again.
No hot water or steam.	The nozzle is obstructed.	Clean nozzle out with needle. Dial is closed! The machine is switched off!
Machine heating takes a long time.	The machine is heavily calcified.	Descalcify the machine.
The brewing unit cannot be removed.	The brewing unit has stopped in an incorrect position.	Close doors and switch on the machine. The machine performs a re-positioning.
Coffee dispensing insufficient or absent.	Grind too fine.	Set grind to higher level. Turn knob in clockwise direction.
	SBS is set to the right side.	Turn SBS knob to the left.

Cannot dispense	
The descaling indicator flashes (machine not locked)	- Descale
Water LED lights up	- Fill with fresh water
Water LED flashes	- De-aerate machine
Coffee beans/grinds container LED lights up	- Fill with coffee beans
Coffee beans/grinds container LED flashes	- Empty grinds container (for min. 6 sec. / machine must be turned on)
Warning LED lights up	- Correctly install brewing unit, drip tray and grinds container, and close door.
Warning LED flashes	- Grinder obstructed. - Gears obstructed - Contact an authorised service centre.
Filter indicator flashes (machine not locked)	- Replace Aqua Prima filter / turn indicator off (press the hot water button for about 6 sec. until filter indicator light flashes).

2.3. User programme (Incanto classic)

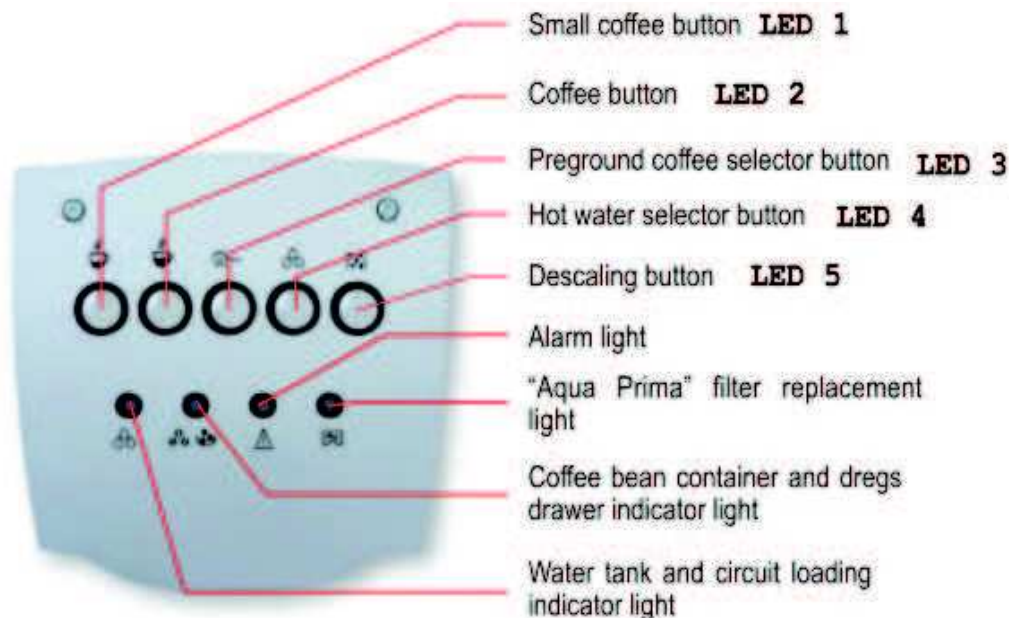

The table below indicates the various settings and programmes which can be selected through the user programme options.

Access: The machine must be turned on with the espresso and hot water buttons pressed in order to enter the programming mode.

Function	Button	Status	LED indicator	
			Without filter	With filter
Water hardness setting for descaling indicator	Powder coffee (Press to activate an additional LED and then change descaling interval.)	0 – very soft water (0° - 3°dH) 800l	1	
		1 – soft water (4° - 7°dH) 400l	1+2	1
		2 – medium water (7°-14°dH) 200l	1+2+3	1+2
		3 – hard water (14°-21°dH) 100l	1+2+3+4	1+2+3
		4 – very hard water (over 21°dH) 50l	1+2+3+4+5	1+2+3+4
				When using a filter, the next interval can be chosen.
Rinse programme	Espresso	ON/OFF (LED lit up means programme activated)	Water Low LED	
Pre-brewing	Coffee	ON/OFF (LED lit up means programme activated)	Coffee Beans Low LED	

3. Operation (Incanto de luxe)



3.1 Control panel

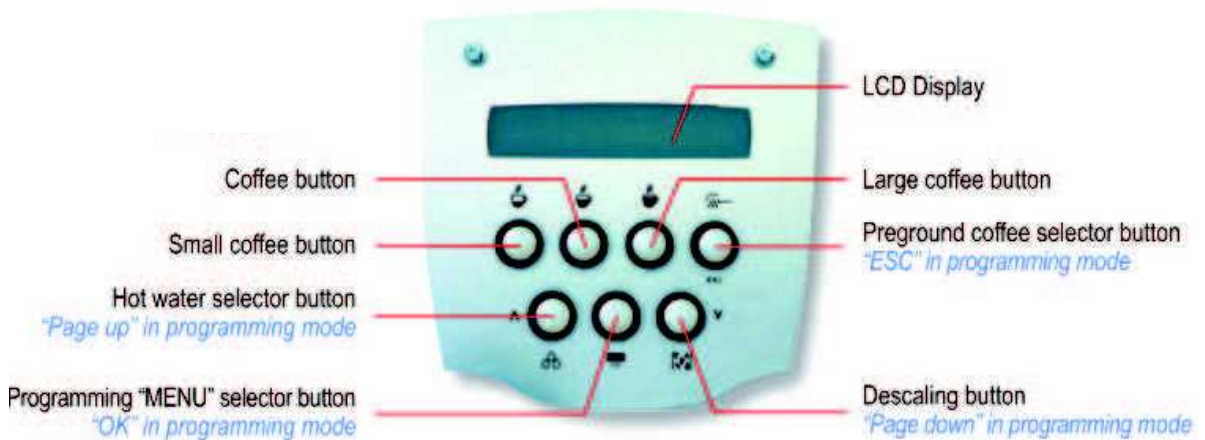

3.2. Operating instructions (quick reference)

	Action	Comments	Display
Getting started			
1	Unpack machine.	Check for damage.	
2	Install Aqua Prima filter.		
3	Fill water tank	Wait for 30 min.	
4	Fill coffee beans container.		
5	Connect mains plug.		
6	Turn on main switch.		Self test/ Heating
7	De-aerate water circuit.	Press hot water button. Open hot water pressure valve until water flows.	Hot water Heating
		Heating stage (approx. 80 sec.)	Heating
		Ready	Select product Ready for operation
8	Activate water filter.	Activate counter + reset	Filter symbol
9	Set water hardness.	See user menu.	
Making coffee			
10	Programme coffee quantity for each selection button. <ul style="list-style-type: none"> • Espresso lungo • Coffee • Espresso 	Depending on cup size. Programme by keeping the coffee selection button pressed until the desired quantity is reached.	Quantity programme
11	Set dispensing time. Place cup under dispenser.	Only machines with SBS	Select product Ready for operation
12	Select programme and press appropriate button.	Press once = 1 cup of coffee Press twice = 2 cups of coffee.	1 Coffee 2 Coffees
Coffee dispensing / Powder coffee			
13	Place cup under dispenser.	Place powder coffee in powder container (1 measuring spoonful)	
14	Press powder button and select relevant coffee button (expresso lungo / coffee / expresso)	Only one coffee can be dispensed at a time.	Select product Powder coffee
Dispensing steam			
15	Open HWS valve	Immediately ready	Steam
Hot water dispensing			
16	Press hot water button.	Immediately ready	Select hot water / product Ready
17	Open HWS valve	Water removed	HOT WATER
18	Close HWS valve	Water removal complete	Select hot water / product Ready
19	Press hot water button.	Steam mode	Select product Ready for operation

Cleaning	
Empty dregs drawer	Storage capacity of 12 tablespoons (Reset - empty only when indicated and with machine on)
Empty drip tray	After 12 servings
Clean water tank.	As required.
Clean coffee bean container.	As required.
Clean the housing.	As required.
Rinse brewing unit	1 x per week
Clean brewing unit and lubricate Clean filter	1 x per month
Descale	According to indicator.

Descaling procedure		
Action	Comments	Indication
		Descale
Remove the Aqua Prima filter.		Descale
Fill tank with descaler solution.	Place an appropriately sized container under the HWS nozzle.	Descale
Press descaling button		Descale Open dial.
Open HWS valve	The pipes are rinsed with descaler at intervals. (Duration: approx. 45 min)	Machine is descaled.
Programme end	When water tank is empty	Descaling complete Close dial.
Close HWS valve	Descaling programme complete.	Rinse machine Fill water tank
Fill tank.		Rinse machine. Press button
Press descaling button		Rinse machine. Open dial.
Open HWS valve		Machine is rinsed
Programme end	When water tank is empty	Rinsing complete Close dial.
Close HWS valve	Rinse programme complete	Fill water tank.
Fill tank.		De-aerate
Open HWS valve	Until water is continuously discharged.	Hot water
Close HWS valve		Select product Ready for operation
Install Aqua Prima filter.		Select product Ready for operation

The descaling indicator turns off automatically after completion of the descaling process!

Display indicators

Standby	Press MENU/OK button.
Descaling Standby	Descale machine.
Fill water tank	Fill water tank with fresh drinking water.
Bean less Ready	Fill coffee beans container and re-start coffee dispensing cycle.
Empty the dregs drawer	Open the doors, remove the grinds container and empty.

Important: The grinds container must only be emptied when the machine is turned on. The container must be removed for at least 5 sec. If the grinds container is emptied when the machine is turned off, coffee dispensing will be locked when the machine is turned on.

Brewing unit not detected	Install brewing unit correctly.
Dregs drawer not detected	Install drip tray and coffee grinds container correctly.
Close doors	Close front door.
Ventilate	Prime the circuit (start-up).
Brewing unit locked	Call authorised service centre.
Grinder locked	Call authorised service centre.
Rinse Heat	The machine is in the heating stage; wait until this stage is complete.

Replace water filter
Standby

Replace the Aqua Prima filter as soon as possible.
If a new filter is not available, remove the current filter and turn off the Water Filter function (see Programming).

Important information about the Aqua Prima filter

1. Store the Aqua Prima filter in a cool place, protected from sunlight. The room temperature must be between +5°C and +40°C.
2. Use the filter in rooms where the temperature does not exceed 60°C.
3. We recommend washing the Aqua Prima filter when the coffee machine has not been used for 3 days.
4. If the coffee machine has not been used for 20 days, we recommend replacing the filter.
5. Store unpacked filters in an airtight nylon bag and place in a refrigerator. Do not place the filter in the freezer as this will change the filter's characteristics.
6. Immerse the filter in the water tank 30 minutes before use.
7. Once the packaging has been opened, do not store the filter without any wrapping.
8. The filter must be replaced 90 days after unwrapping or after processing 60 litres of drinking water.

Troubleshooting		
Fault	Cause	Remedy
The machine does not switch on.	The machine is not connected to the mains power supply.	Turn on main switch. Check plug and connection.
	The cups are cold.	Pre-heat cups.
The coffee is not hot enough.	A low temperature has been set.	Set the machine to a higher temperature.
	No powder coffee has been filled.	Fill powder coffee and start once again.
Only hot water is dispensed when powder coffee is selected.		
No hot water or steam.	The nozzle is obstructed.	Clean nozzle out with needle. Dial is closed! The machine is switched off!
Machine heating takes a long time.	The machine is heavily calcified.	Descalc the machine.
The brewing unit cannot be removed.	The brewing unit has stopped in an incorrect position.	Close doors and switch on the machine. The machine performs a re-positioning.
Coffee dispensing insufficient or absent.	Grind too fine.	Set grind to higher level. Turn knob in clockwise direction.
	SBS is set to the right side.	Turn SBS knob to the left.

3.3. User programme (Incanto de luxe)

The table below indicates the various values, settings and programmes which can be read and selected through the user programme options.

Various cleaning programmes can also be activated

Access: Access via Menu/OK button.

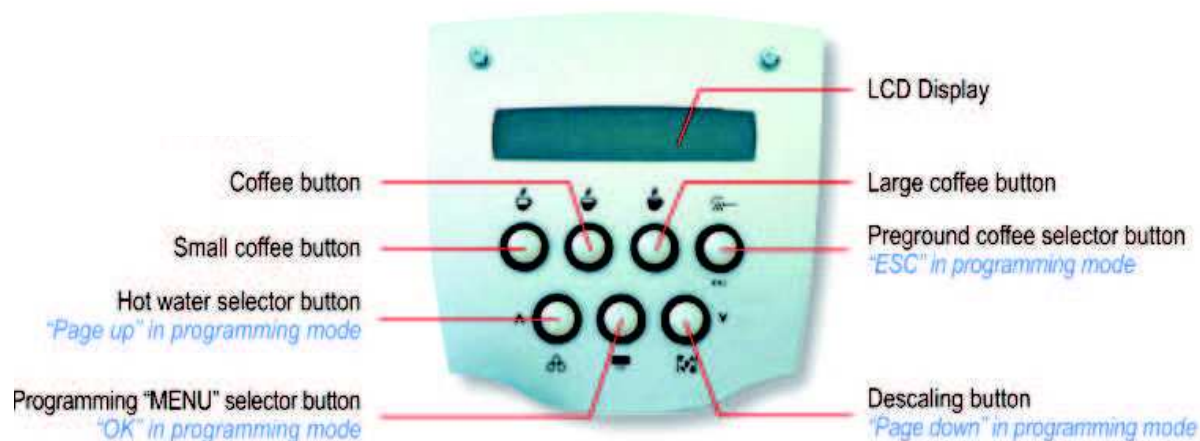

Menu procedure:

1. Select desired programme using the cursor buttons (arrow buttons).
2. Access appropriate item using the Menu/OK button.
3. Use the arrow buttons to handle each item.
4. Confirm with Menu/OK button.

Item	Setting/Indicator	Standard	Function
Standby			
Rinse	ON/OFF	OFF	Rinse the brewing unit with fresh water each time the machine is turned on (boiler temperature below 50°C).
Language	Country	German	Display language
Water hardness	1 – 400 l	3	Descaling interval depending on water hardness.
	2 – 200 l		
	3 – 100 l		
	4 – 50 l		
Water filter	ON	OFF	If ON, only every second flow meter pulse is counted for water descaling purposes (descaling interval doubled).
	OFF		
	Reset		Reset filter counter (generates the indicator to change the filter after every 60,000ml).
Heating plate	ON/OFF	ON	Activate / deactivate heating plate. Heating plate
Temperature	High	Medium	Adjustment of brewing temperature (approx. +/- 2°C)
	Medium		
	Low		

Item	Setting/Indicator	Standard	Function
Aroma Espresso	Strong	Normal	Programming the dosage for the espresso programme (changes the grinder pulses).
	Normal		
	Mild		
Aroma Coffee	Strong	Normal	Programming the dosage for the coffee programme (changes the grinder pulses).
	Normal		
	Mild		
Aroma Espresso lungo	Strong	Normal	Programming the dosage for the espresso lungo programme (changes the grinder pulses).
	Normal		
	Mild		
Pre-brewing	ON	ON	Coffee is moistened before actual brewing (better aroma)
	LONG		
	OFF		
Total coffee	Number		Coffee quantity indicator
Timer	00:15 – 03:00	03:00	Activates standby mode if no dispensing takes place within a specific time.
Clock timer	Time	00:00	Time setting.
	Switching time	00:00	Enters activation time.
		00:00	Enters activation time.
	Time display	YES/NO	Indicates the time on the display.
Clock timer	ON/OFF	Activates/deactivates clock timer.	
Cleaning cycle			Cleaning programme for brewing unit
Factory settings			Initialise standard data

Exit: ESC button

4. Operation (Incanto sirius)

4.1 Control panel

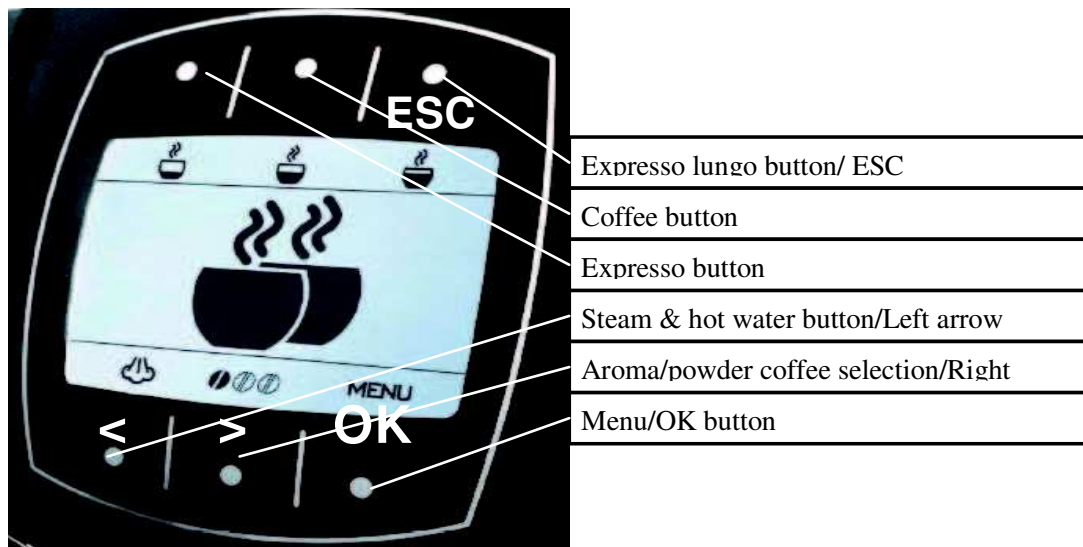

4.2. Operating instructions (quick reference)

	Action	Comments	Display
Getting started			
1	Unpack machine.	Check for damage.	
2	Install Aqua Prima filter.	Activate counter + reset	
2	Fill water tank	Wait for 30 min.	
3	Fill coffee beans container.		
4	Connect mains plug.		
5	Turn on main switch.		Self test/ Heating
6	De-aerate water circuit.	Press hot water button. Open hot water pressure valve until water flows.	Hot water Heating
		Heating stage (approx. 80 sec.)	Heating
		Ready	Select product Ready for operation
7	Set water hardness.		
Making coffee			
8	Programme coffee quantity for each selection button. <ul style="list-style-type: none"> • Expresso lungo • Coffee • Expresso 	Depending on cup size. Programme by keeping the coffee selection button pressed until the desired quantity is reached.	Quantity programme
9	Set dispensing time. Place cup under dispenser.	Only machines with SBS	Select product Ready for operation
10	Elect programme and press	Press once = 1 cup of coffee	1 Coffee

	appropriate button.	Press twice = 2 cups of coffee	2 Coffees
--	---------------------	--------------------------------	-----------

Coffee dispensing / Powder coffee			
11	Place cup under dispenser.	Place powder coffee in powder container (1 measuring spoonful)	
12	Select aroma / Press powder button until the powder spoon appears and select relevant coffee button (expresso lungo / coffee / expresso)	Only one coffee can be dispensed at a time.	
Dispensing steam			
13	Open HWS valve	Immediately ready	Steam
Hot water dispensing			
14	Press steam/hot water button (picture of drops appear on display).	Immediately ready	Select product Ready for operation
15	Open HWS valve	Water removed	HOT WATER
16	Close HWS valve	Water removal complete	Select product Ready for operation
17	Press steam/hot water button (picture of steam appears on display).	Steam mode	Select product Ready for operation

Cleaning		
	Empty dregs drawer	Storage capacity of 12 tablespoons (Reset - empty only when indicated and with machine on)
	Empty drip tray	As required.
	Clean water tank.	As required.
	Clean coffee bean container.	As required.
	Clean the housing.	As required.
	Rinse brewing unit	As required.
	Clean brewing unit and grease filter.	1 x per month
	Descale	According to indicator.

Descaling procedure		
Action	Comments	Indication
		Descale
Remove the Aqua Prima filter.		Descale
Fill tank with descaler solution.	Place an appropriately sized container under the HWS nozzle.	Descale
Press menu button.		STANDBY
Use arrow button to access menu item Clean.		CLEANING
Press OK.		CLEANING CYCLE
Go to DESCALING CYCLE by using the arrow button.		DESCALING CYCLE

Action	Comments	Indication
Press OK.		NO
Go to YES by using the arrow button.		YES
Press OK.		OPEN DESCALE DIAL.
Open dial.		DESCALING
Open HWS valve	The pipes are rinsed with descaler at intervals. (Duration: approx. 45 min)	MACHINE IS DESCALED.
Programme end	When water tank is empty	DESCALING COMPLETE. CLOSE DIAL.
Close HWS valve	Descaling programme complete.	RINSE MACHINE FILL WATER TANK
Fill tank.		RINSE MACHINE PRESS BUTTON
Press button required.		RINSE MACHINE OPEN DIAL.
Open HWS valve		MACHINE IS RINSED.
Programme end	When water tank is empty	RINSING COMPLETE. CLOSE DIAL.
Close HWS valve		FILL WATER TANK.
Install Aqua Prima filter.		DE-AERATE
Fill water tank.		DE-AERATE
Open HWS valve		HOT WATER
Close HWS valve		SELECT PRODUCT. READY

The descaling indicator turns off automatically after completion of the descaling process!

Troubleshooting		
Fault/Indicator	Possible cause	Remedy
Does not function	No power	Check mains plug / mains circuit breaker. Ensure machine door is closed.
BREWING UNIT NOT DETECTED	Brewing unit not properly installed or not closed.	Install brewing unit correctly.
GRINDS CONTAINER NOT DETECTED	Coffee grinds container not properly installed.	Brewing unit correctly installed.
EMPTY GRINDS CONTAINER	Coffee grinds container full	Empty coffee grinds container (reset only possible if machine is turned on)
COFFEE BEAN CONTAINER EMPTY	Coffee bean container is empty.	Fill coffee container.
FILL WATER TANK.	Water tank is empty.	Fill water tank
GRINDER OBSTRUCTED		Clean grinder.
DE-AERATE	Air in water system.	Open water nozzle.
REPLACE WATER FILTER		Replace water filter + reset user menu
Instead of coffee, only water is dispensed.	Coffee powder selection button is pressed, but no coffee powder is dispensed.	Add one level measure of coffee powder.
No water / steam	Steam nozzle blocked.	Free opening using a thin needle.
The coffee flows too quickly	Beans ground too coarsely.	Press knob and turn in the direction of the small points.
The coffee flows too slowly	Beans ground too finely.	Press knob and turn in the direction of the large points.
Coffee is not hot enough	The cups are cold.	Pre-heat cups.
	Boiler temperature too low.	Increase temperature in user programme.
Coffee has no froth.	Unsuitable coffee blend.	Change brand of coffee.
	Coffee is no longer freshly roasted.	Use fresh coffee.
	Beans ground too coarsely or finely.	Change grinding level.
Longer heating time or less hot water.	The machine is calcified.	Decalcify machine.
The brewing unit cannot be removed.	The brewing unit is not in home position.	Turn machine on, close service door and check dregs drawer. (the brewing unit goes automatically to home position)

4.3. User programme (Incanto sirius)

The table below indicates the various values, settings and programmes which can be read and selected through the user programme options.

Various cleaning programmes can also be activated.

Access: Selection entry via menu button.

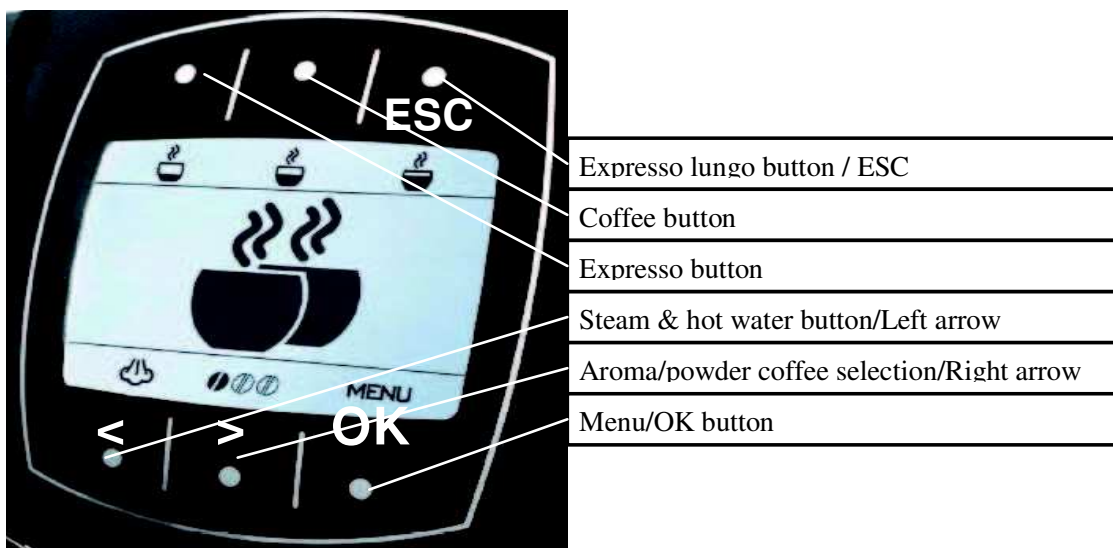

Menu procedure:

1. Select desired programme using the cursor buttons (arrow buttons).
2. Access appropriate item using the OK button.
3. Use the arrow buttons to handle each item.
4. Confirm with Menu/OK button.

	Item	Setting/ Indicator	Standard	Function
	STANDBY			Display and heating OFF.
SETTINGS	HEATING PLATE	ON	ON	Activate / deactivate heating plate. Heating plate
		OFF		
	RINSE	ON	OFF	Rinses when the machine is turned on and the temperature of the KTY is below 50°C (circuit and brewing unit).
		OFF		
	LANGUAGE	Country	German	Display language
	WATER HARDNESS	1 – 400 l	3	Change in water flow quantity until descaling required (1-4).
		2 – 200 l		
3 – 100 l				
4 – 80 l				
WATER FILTER	ON	OFF	When Aqua Prima filter is used, the water filter item must be turned ON. When replacing the filter, the counter must be reset.	
	OFF			
	RESET			
CONTRAST	-5 - +5	-3	Display contrast / Light	

	Item	Setting/Indicator	Standard	Function
	SIGNSLTON	ON	ON	Button tone.
		OFF		
	FACTORY SETTINGS	NO	NO	Initialise standard data
		YES		
COFFEE SETTINGS	PRE-BREWING	ON	ON	The coffee comes into contact with a small amount of water in the brewing unit prior to the actual brewing process (stronger aroma).
		OFF		
		LANG		
	EXPRESSO TEMPERATURE	High	Medium	The user can determine the brewing temperature ($\pm 2^{\circ}\text{C}$).
		Medium		
		Low		
COFFEE TEMPERATURE	See espresso	Medium	The user can determine the brewing temperature ($\pm 2^{\circ}\text{C}$).	
TEMPERATURE EXPRESSO LUNGO	See espresso	Medium	The user can determine the brewing temperature ($\pm 2^{\circ}\text{C}$).	
AROMA SELECTION	Mild	Normal	Pre-set aroma selection (1, 2 or 3 coffee bean setting) on display (= dosage 8g for NORMAL $\pm 1.5\text{g}$).	
	Normal			
	STRONG			
TIME SETTING		TIME DISPLAY	YES/NO	Indicates the time on the display.
		TIME		Time setting.
		TIME FORMAT	AM/PM 24H	12-hour or 24-hour clock From Version 2.00.3
		CLOCK TIMER	ON/OFF	Activates/deactivates clock timer.
		SWITCHING TIME	00:00	Enter activation times
		TIMER	00:00	Enter activation times
CLEANING		Cleaning cycle	YES/NO	Brewing unit cleaning programme
		Descaling cycle	YES/NO	Starts automatic descaling (approx. 45 min.)
EXTRAS	TOTAL COFFEE	EXPRESSO	NUMBER	Counts number of times coffee is Dispensed (not resettable).
		COFFEE	NUMBER	
		EXPRESSO LUNGO	NUMBER	

Exit: ESC button

CHAPTER 4

FUNCTIONS AND TIMING

	Page
1. Water system	1
1.1. Water system (Incanto rondo)	1
1.2. Water system (Incanto classic) (Incanto de luxe) (Incanto sirius)	2
2. Electrical system	-
3. Timing	3
4. Function	4
4.1. Gearmotor	4
4.2. Gear resistor	4
4.3. Water level monitoring	4
4.4. Flow meter (turbine)	5
4.5. HWD valve (steam operation)	5
4.6. Temperature sensor (KTY)	5
4.7. Grinder	6
4.8. Dosing	6
4.9. SBS Saeco Brewing System	7
4.9.1 General functions	7
4.9.2 Frothing valve function	8
4.9.3. Extraction values with SBS	9

1. Water system

1.1. Water system (Incanto rondo)

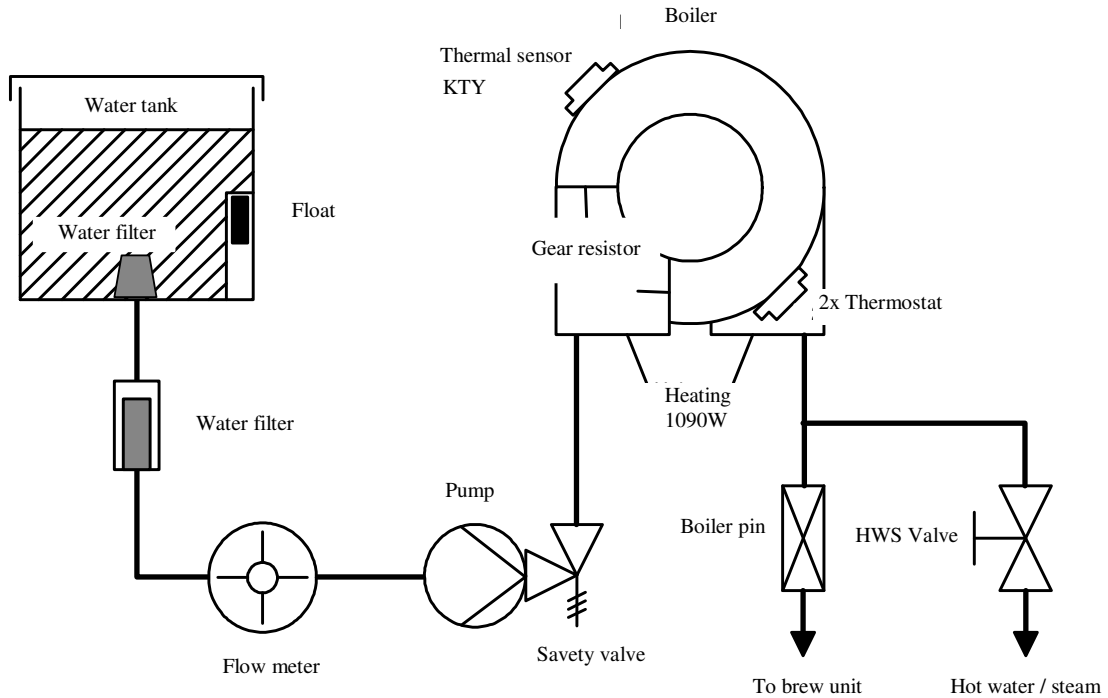

Component	Function
Water tank	Water supply
Float	Water level monitoring
Water filter	Water cleaned of solid matter (one or two depending)
Flow meter (turbine)	Measure flow rate
Pump	Water flow/Pressure build-up (13 to 15 bar)
Safety valve	Protect boiler against overpressure (opens at 17 bar)
Boiler (flow heater)	Heats water to approx. 84°C (for brewing process)
Sensor (KTY)	Transmits current temperature value to electronic system
Thermostat	Interrupts complete flow supply if overheating.
Boiler pin (Valve plug)	Opens when brewing unit is aligned with water circuit to the unit itself.
HWS valve	For hot water and steam dispensing

1. 2. Water system (Incanto classic, de luxe, sirius)

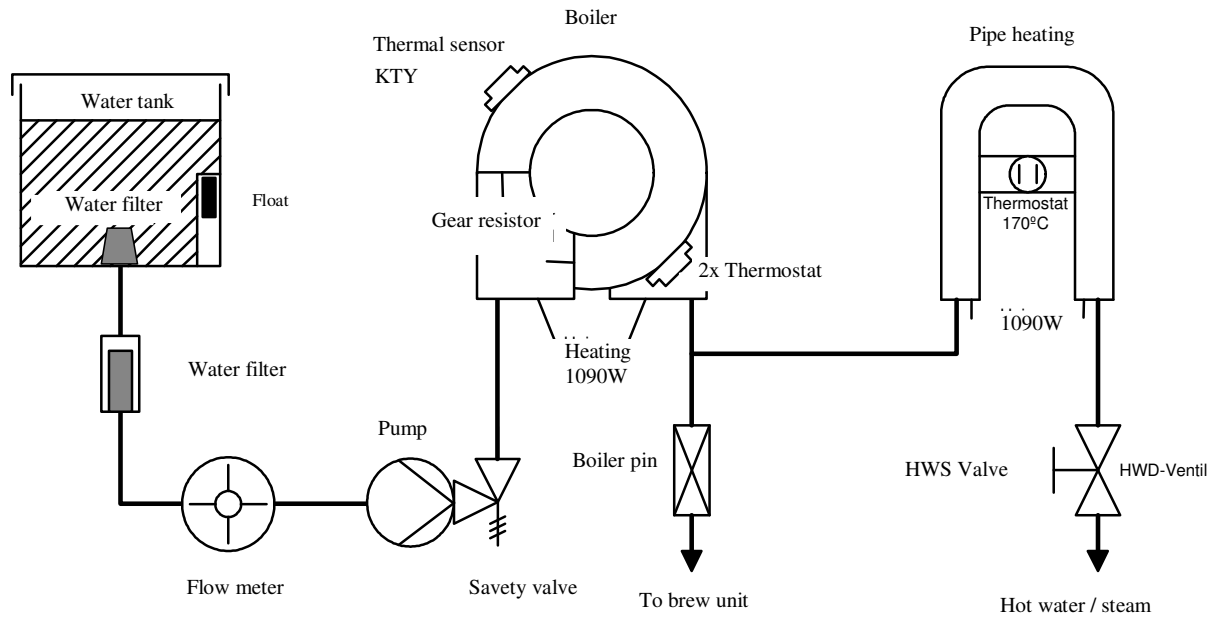

	Component	Function
1	Water tank	Water supply
2	Water filter	Water cleaned of solid matter (one or two depending)
3	Flow meter	Measure flow rate
4	Pump	Water flow/Pressure build-up (13 to 15 bar)
5	Safety valve	Protect boiler against overpressure (opens at 17 bar)
6	Boiler (flow heating)	Heats water to approx. 94°C (for brewing process)
7	Sensor	Transmits current temperature value to electronic system
8	Thermostat	Turns off flow supply to entire machine if overheating.
9	Boiler pin (Valve plug)	Opens when brewing unit is aligned with water circuit to the unit itself.
10	Pipe heating	Steams pre-heated boiler water for steam function.
11	Thermostat (pipe heating)	Switches (pulses) pipe heating
12	HWS valve (tea nozzle)	For hot water and steam dispensing

3. Timing

The following time chart indicates the functions of the individual components in terms to time

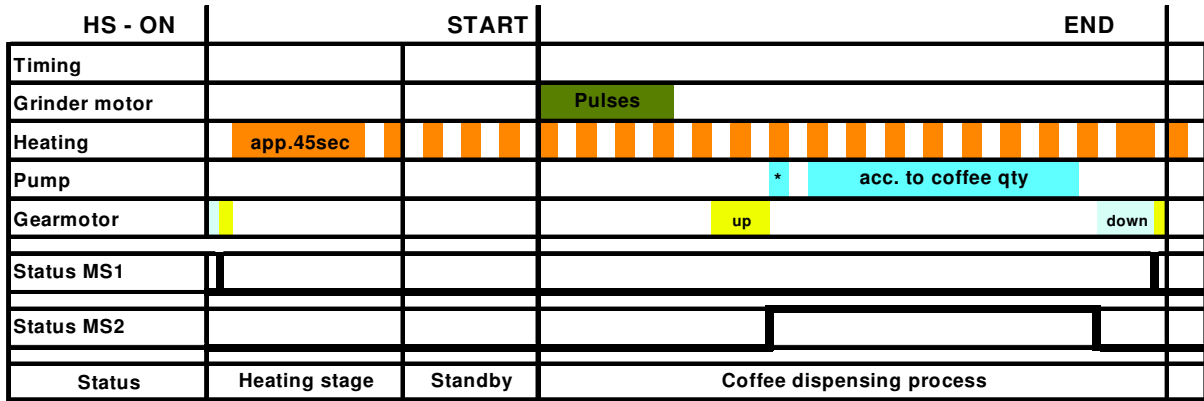

Explanation:

Two processes start when the main switch is activated:

Firstly, the gearmotor is initialised. The gears move to MS1 (lower limit switch), change rotating direction, leave MS1 and move to the home position (about 2 mm after MS1).

The instantaneous water heater is then activated for about 1 min 30 sec., heating the water to operating temperature, whereby heating takes place for about 60 sec. continuously and then is alternated for the rest of the time.

After activating the start button:

1. The grinder starts operating (pulse-controlled).
2. The gears move to brewing position.
3. Pre-brewing begins (brief pump activation).
4. Main brewing process (duration of pump activation depending on selected coffee quantity).
5. The gears move to home position (dregs discarded).

4. Function

4.1. Gearmotor

The gearmotor is connected to the power element of the circuit board via the auxiliary heating system. In order to perform forwards and backwards movements, the gearmotor is controlled alternately with a positive and negative half wave. The voltage is limited by the electronic system to approx. 30 to 35 V. The electronic system of the motor is switched off in the event of an overload. The overload is detected through the increased power input to the gearmotor during the stoppage. The red fault LED/brewing unit lock indicator turns on.

If the brewing unit is locked in the upward movement, the cycle is interrupted after about 8 seconds and the control system attempts to move the brewing unit to the idle position. This occurs, for instance, when too much powder is present in the brewing chamber. If the brewing unit is locked in the downward movement, the motor turns off after 8 seconds and the machine is locked. This situation is indicated by the flashing fault LED / brewing unit lock indicator. The machine must be turned off and the cause of the lock removed.

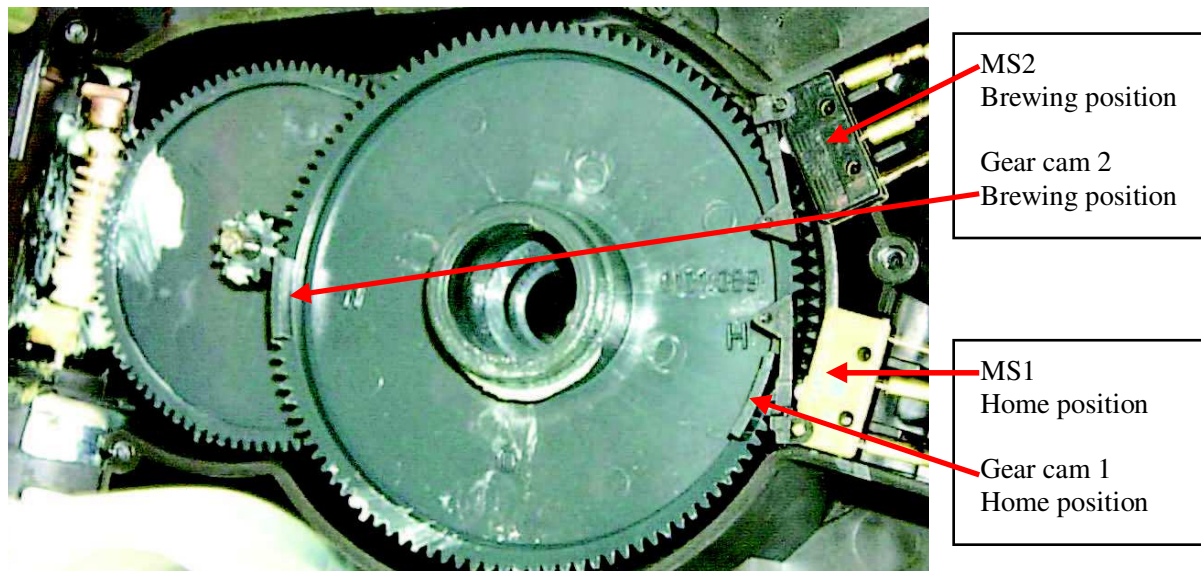

Note: The gear wheel must always be installed so that MS1 and MS2 are positioned at the long section of the switching cams!

4.2. Gear resistor

The heating system of the thermoblock with green marking at the connection point acts as resistor for the gearmotor. The gearmotor cannot function in the event of a defective heating system. The heating system (resistor) has a resistance of approx. 130 Ohm.

4.3. Water level indicator

The water level in the water tank is monitored by a float fitted with a magnet core. If the water level is too low, the magnet is no longer within the range of the reed contact, which transmits the low water level signal to the CPU (Water Low indicator).

4.4. Flow meter (Turbine)

The machine is equipped with a flow rate monitoring system. The system checks whether the turbine (flow meter) rotation speed at a particular time complies with the pre-set value. If no pulses are generated from the turbine within 10 seconds, the current cycle is interrupted. The Fault - De-aerate signal is indicated. If this control mechanism is activated, the machine must be de-aerated. During the Water Low signal, the pump operates at maximum output. As soon as the pump has generated the pre-set flow, the pump output is reduced to approx. 20 l/hr.

The water quantity is generally controlled according to the coffee quantity programmed through the flow meter (turbine) pulses.

4.5. HWS valve (steam operation)

The HWS valve is required for water and steam dispensing, as well as during de-aeration.

If the hot water valve is opened during the brewing process, coffee flow is interrupted and the De-aerate indicator will appear. As soon as the hot water valve is closed, the brewing process will continue.

The operating temperature during steam dispensing is approx. 125°C. The steam button is pressed to activate steam production (without rapid steam). Steam dispensing occurs via the HWS valve.

The pump pulses the steam dispensed. This means that constant steam dispensing is ensured over a long period of time. The flow rate of the pump is adjusted on the basis of the thermoblock temperature. If the temperature is too low, the pump pulses are slowed down. This may occur, for instance, when the hot water valve opens before the temperature indicator lights up (without rapid steam).

Once the steam has been dispensed, the steam valve closes and the steam button must be pressed for normal operating mode. The overheating indicator flashes until the machine has cooled; the machine remains locked for coffee dispensing. Cooling can be achieved by opening the HWS valve. The pump functions at maximum output and the heating remains turned off as long as the Overheating signal remains. These measures ensure that the cooling process is accelerated and the overheating signal will disappear after a few seconds.

4.6. Temperature sensor (KTY 10)

The temperature sensor is a temperature-sensitive resistance mechanism, converting the boiler temperature into an electrical signal which is measurable by the CPU.

The CPU compares this signal with the programmed reference signal and, depending on the outcome of the comparison, controls the boiler output.

The resistance applied has a positive temperature coefficient; i.e. higher boiler temperature - higher sensor resistance.

The table below indicates the trend in resistance values in relation to the temperature.

Measured values (KTY)

Temperature	Resistance (Ω)	Resistance trend (Ω)
0	1629	0
15	1845	216
20	1922	77
40	2246	324
90	3168	922
100	3366	198
130	3979	613
140	4188	209

At room temperature the resistance is approx. 1.9K Ω .

4.7. Grinder

The grinder is fitted with grinding discs. The grinding discs are made of ceramics.

ATTENTION: Adjust the grinding level only when the grinder is in operation!

EXCEPTION: Grinder is empty.

The grinder operates with a direct current motor and the grinding disc rotation speed is determined by a gearmotor. The grinder motor operates with a voltage of 230V direct current.

Grinder obstructed: Gravel protection is electronically controlled. If the grinder is obstructed, the power input to the grinder motor increases and the electronic system switches the grinder off.

If the electronic system does not receive any pulses from the grinder Hall sensor, the grinder blocked signal will be generated.

Coffee beans low: The lack of coffee beans is detected via the power input. If there are no coffee beans in the grinder, the motor runs without a load and, therefore, consumes less power. This is detected by the control unit and the coffee beans low signal is generated.

4.8. Dosing

Gravel protection is electronically controlled. Two magnets positioned opposite to each other are fitted on the grinder disc gear wheel. The Hall sensor monitors the number of rotations of the grinding discs and, therefore, also the dose quantity.

Incanto rondo control: Via a potentiometer in the electronic system

Incanto classic control: Via service programme / test mode

Incanto de luxe control: Via aroma selection function (user menu)

Incanto sirius control: Via aroma selection function (user menu)

4.9. SBS Saeco Brewing System

4.9.1. General functioning

The water flow speed through the brewing unit can be slowed or accelerated by means of an adjustable flow valve (Fig. 2) which is activated by turning the knob on the front of the coffee machine.

The contact time of the water with the coffee in the brewing unit (extraction time), and consequently, the coffee concentration, is changed accordingly, while maintaining consistent froth formation.

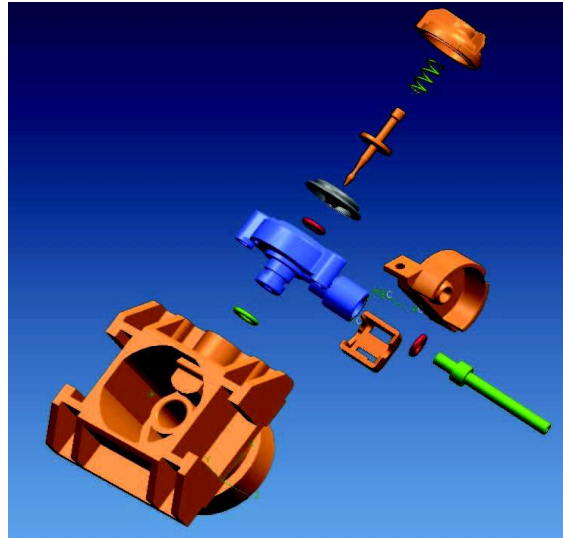

Fig. 1

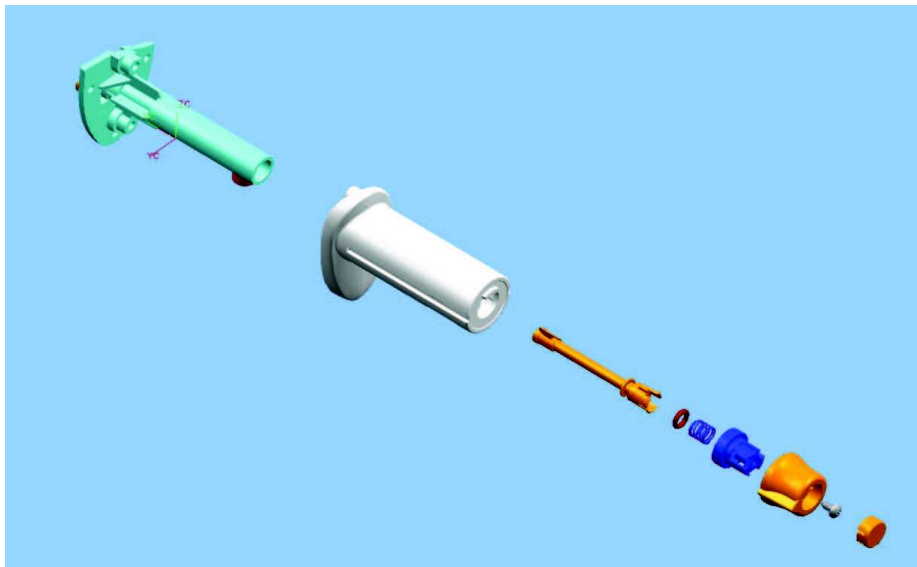

Fig. 2

4.9.2. Froth valve functioning

The backpressure in the froth valve and, consequently, on the membrane of the froth valve, is minimal when the flow valve is open. Accordingly, the valve needle is kept by the spring pressure in almost home position and the flow is at maximum (Fig. 3).

If the flow valve moves towards a minimum position, a backpressure results which creates an increased pressure on the membrane in the valve chamber. The membrane yields to the pressure and the valve needle further reduces the flow speed (Fig. 4).

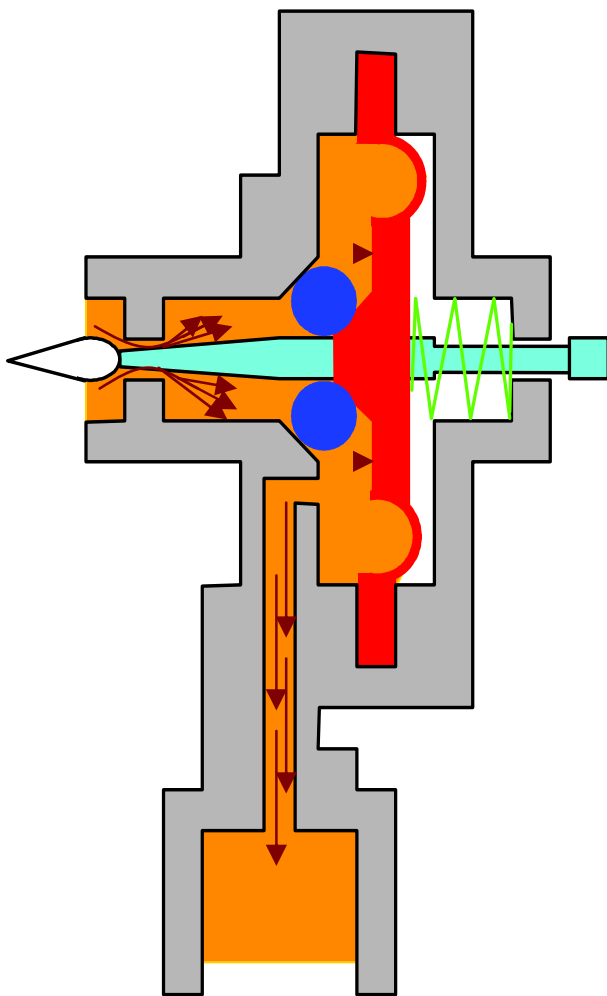

Fig. 3

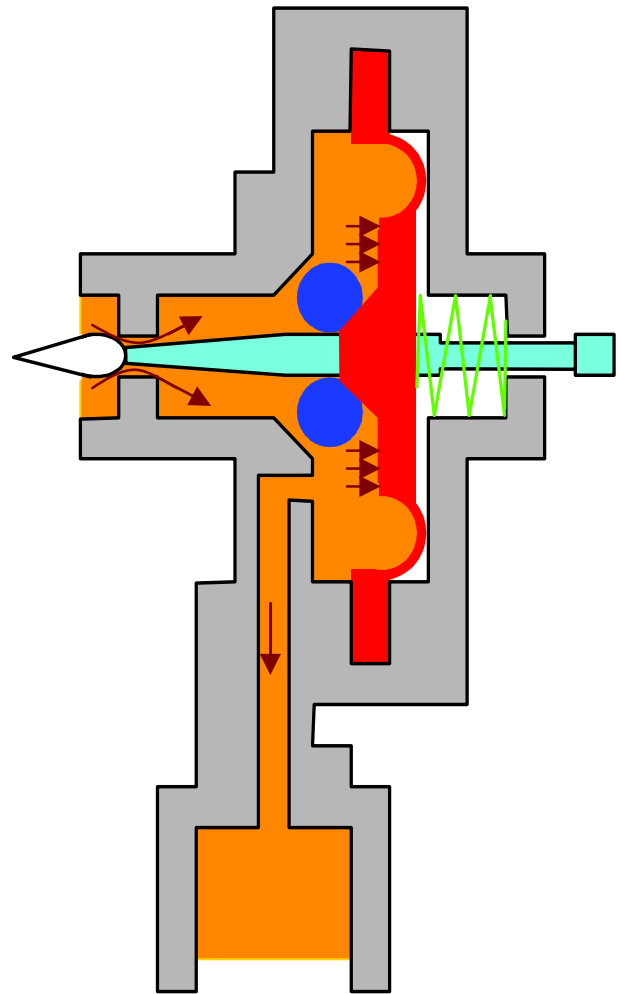

Fig. 4

4.9.3. Extraction values with SBS

A comparison of the measured values (dosing quantity 9g/SBS min.; dosing quantity 9g/SBS max. and dosing quantity 6g/SBS min.) indicates that the change from SBS min. to SBS max. corresponds with a change in dosing quantity of 1.5g.

Note: The pre-brewing function was deactivated during measuring.

CHAPTER 5

SERVICE PROGRAMME

	Page
1. Service programme (Incanto rondo)	1
1.1. Test mode	1
2. Service programme (Incanto classic)	2
2.1. Test mode	2
2.2. Diagnosis menu	4
3. Service programme (Incanto de luxe)	7
3.1. Test mode	7
3.2. Diagnosis menu	9
4. Service programme (Incanto sirius)	12
4.1. Test mode	12
4.2. Diagnosis menu	15

1. Service programme (rondo)



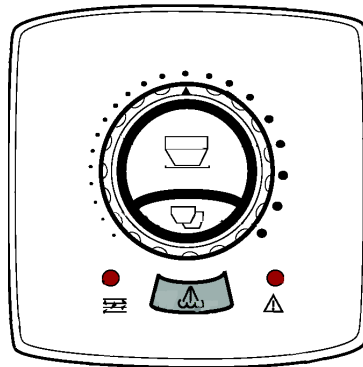

1.1. Test mode

Access: Access the service mode by turning on the machine and simultaneously pressing the 1 Coffee and steam buttons.

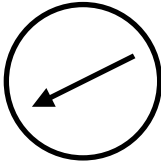

Various test functions can be activated in the service mode by activating either the coffee or steam buttons in conjunction with various coffee quantity settings.

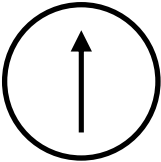
Programme table

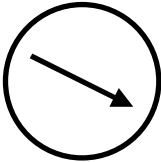
Function	Button	Control setting Cup fill volume	LED Indicator
Pump/Flow meter	1 coffee		Alarm LED (Flow meter pulse)*
Aqua Prima LED	2 coffees		Aqua Prima
Brewing unit (Gearmotor) Work position 	Steam		1 Coffee LED (Gear switch)
Heating	1 coffee		
Brewing unit (Gearmotor) Home position 	Steam		1 Coffee LED (Gear switch)
Grinder	Steam		Fault LED (grinder pulses)
HWS microswitch			Steam LED lights up
Reed switch			1 Coffee LED lights up
Brewing unit switch			2 Coffees LED flashes
Grinds container microswitch			Aqua Prima LED + Fault LED flash
Door switch			Aqua Prima LED flashes

* The HWS valve must be open.

2. Service programme (Incanto classic)

2.1. Test mode

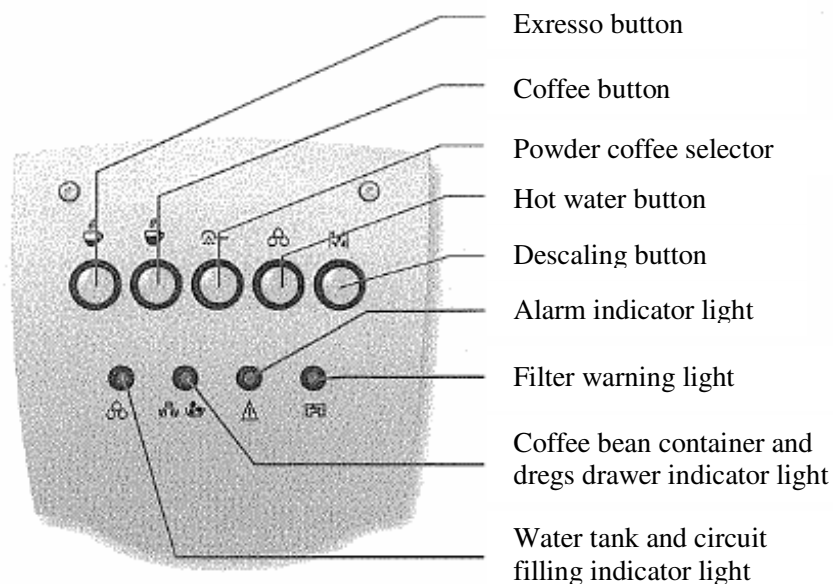

Access: Access the service mode by turning on the machine and simultaneously pressing the coffee and hot water buttons.

The various functions indicated in the table can be checked by pressing the button combinations listed below.

Programme table (functions programme)

Buttons	Powder coffee	Coffee	Espresso	Hot water	Descale	Microswitch status
Gears up	x					Powder LED (MS2)
Unit down		x				Espresso LED (MS1)
Grinder			x			
Pump				x +HWS		Fault LED (flow meter pulses) *
Heating	x				x	
Heating + LED check	x				x + HWS	

* In order for the flow meter pulse to be indicated, the HWS valve must close once again after opening so that the HWS microswitch re-opens.
If the HWS valve is completely open, the LED combination which lights up provides information on the flow rate (see table below)

Flow rate

The flow rate value must be between 40 and 60.

LED description	Value
Espresso button LED	128
Coffee button LED	64
Powder button LED	32
Hot water button LED	16
Descal button LED	8
Water Low LED	4
Coffee Beans Low LED	2
Fault LED	1

Example: Powder button (32), Descal button (8) and Coffee Beans Low LED (2) light up = 42

Microswitch test

Microswitch	Control LED	Status
Reed switch (tank removed)	Water low	ON
Dregs drawer/Drip tray (removed)	Coffee beans low	ON
HWS switch (open)	Fault	Off
Door switch (doors open)	Descal	ON
Brewing unit (removed)	Hot water	Steam LED

Dose quantity programming

Open hot water valve and press the espresso button.

Depending on the LED combination, the dose quantity can be determined by consulting the table below and can be changed by repeatedly pressing the coffee programme button.

Grinder pulses	Approx. dose quantity in grams	Water Low LED	Coffee Beans Low LED	Fault LED	Replace filter LED
90	7.5	☀			
95	8.0	☀	☀		
100	8.4		☀		
105	8.9		☀	☀	
110	9.2			☀	
115	9.6			☀	☀
120	10.2				☀

2.2. Diagnosis menu (Incanto classic)

Application of diagnosis system

The diagnosis system makes it possible to read data and enter settings into the coffee machine.

ATTENTION: Before connecting the diagnosis box, read the operating instructions (data plug can only be connected and disconnected when both devices are unpowered).

Connection is via contact plug JP 25 of CPU.

Programme table (diagnosis menu)

Function/Standard	Setting range	Increment	Comments
EXPRESSO No. of PULSES 195	50 – 1,000 Pulses	+/- 1	Number of flow meter pulses for each saved cup fill volume, where 300 pulses correspond to approx. 100 ml.
COFFEE No. of PULSES 360	50 – 1,000 Pulses	+/- 1	
----HEATING---- PARAMETER K1 8	1 – 50	+/- 1	Do not change!
----HEATING---- PARAMETER K2 30	1 – 50	+/- 1	Do not change!
NORMAL TEMP. ° C 90	70- 130°C	+/- 1	Normal temperature is used if not more than 6 min. have elapsed since last coffee dispensed.
HIGH TEMP. ° C 111	70- 130°C	+/- 1	If no coffee is dispensed for an extended time (over 6 min.), the next coffee will be heated to a higher temperature to compensate for cooling of the brewing unit and the associated temperature loss.
TEMP. OF 1st COFFEE ° C 118	70- 130°C	+/- 1	Used when dispensing the first coffee after the machine has been turned on, to compensate for the high temperature loss due to the cold brewing unit and water pipes.
STEAM 25	20- 50	+/-1	Pump pulse during steam dispensing The higher the value, the more pulses but more humid is the steam.
TEMP. INCREASE ° C 10	0-50°C	+/-1	The boiler temperature is increased by a set value shortly before brewing in order to pre-heat the boiler and compensate for the temperature drop during the first water flow.

Function	Setting range	Increment	Comments
PRE-BREWING 1	0 – 1		0 – Deactivate pre-brewing 1 – Activate pre-brewing
GRINDS COUNTER Number	0-50	+/-1	Counts number of coffee cycles. When this value reaches the Grinds Stop value, "GRINDS CONTAINER EMPTY" will be displayed. (Reset by removing dregs drawer for emptying - min. 6 sec.)
GRINDS MAXIMUM 12	5-50	+/-1	Number of cycles until "EMPTY GRINDS CONTAINER" is displayed.
--TOTAL COFFEE-- CYCLES Number	-----	-----	Coffee cycle counter /not resettable.
--TOTAL WATER-- (ml) Number	-----	-----	Total water flow volume (in ml) / not resettable
WATER DESCALING (ml)	-----	-----	Total water flow (in ml) since last descaling / resettable
WATER FILTER (ml) Number	0 - 99999999	+/- 1	Total water flow (in ml) since last filter reset (60,000 - replace filter)
HOT WATER FLOW (l/h) 20	6 - 34 l/h	+/- 2 l/h	The pump delivery rate for hot water can be expressed in litres per hour.
--HOT WATER--- PUMP ADJUST. 63000	58,000 - 65,500	+/- 1	The pump delivery rate is adjusted in relation to the HOT WATER FLOW setting by means of a phase controlled modulator. Pump tolerances can thus also be adjusted. An equivalent value is saved under HOT WATER PUMP ADJUSTMENT.
WATER HARDNESS 3	1 – 4		Value set in user menu for descaling interval
MACHINE STATUS 16	0 – 255		Programme code
--DATE OF MANUF--- DAY	-----	-----	This date indicates when the machine was manufactured. This date cannot be changed, but can be printed.
--DATE OF MANUF--- MONTH	-----	-----	
--DATE OF MANUF--- YEAR	-----	-----	

Function	Setting range	Increment	Comments
--SERVICE DATE-- DAY	0 - 31	+/- 1	The service date indicates the date of the machine's last service. This date can be changed and must be updated at each service.
--SERVICE DATE-- MONTH	0 - 12	+/- 1	
--SERVICE DATE-- YEAR	1996 - 2050	+/- 1	

3. Service programme (Incanto de luxe)

3.1. Test mode

Access: Access the test mode from the standby mode (press 2x Menu/OK) by keeping the EXPRESSO LUNGO and HOT WATER button pressed, whilst pressing the MENU/OK button again.

While the buttons are kept pressed, the current software version is shown.

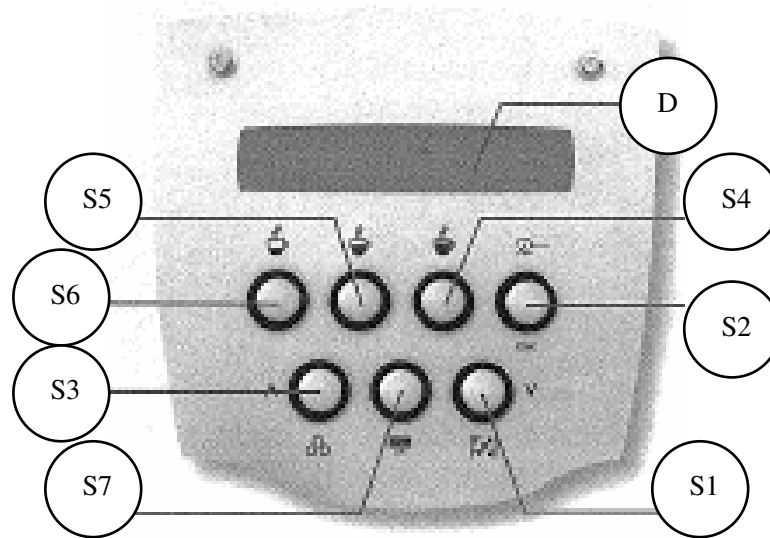

The various functions indicated in the table can be checked by pressing the button combinations listed below.

Programme table (functions programme)

Buttons	S6 Espresso	S5 Coffee	S4 Espresso lungo	S2 Powder coffee	S3 Hot water	S7 Menu/OK	S1 Descale
Unit up	x						
Unit down		x					
Grinder			x				
Pump	x						x
Heating plate	x				x		
Heating system Instantaneous water heater		x				x	
Pipe heating			x			x	
Temperature indicator in °C				x		x	x

Display in test mode:

1234567890	MR (X)
123456	xx

Upper display line:

Indicates the status of the microswitch (see table).

Lower display line:

Indicates the status of the operating buttons.

Flow rate

If the pump is activated during test mode and the hot water valve opened, a two-digit number appears on the bottom right side indicating the flow rate. This value must be between 40 - 60 (should not be below 40).

Grinder power

When the grinder is activated, the grinder power is indicated instead of the flow quantity. Set value: 6-12

The upper display line signals the activated microswitch and the Hall effect of the turbine.

The activated buttons are signalled by the lower display line (e.g. 1=S1, 2=S2, etc.).

All CPU input signals from the machine appear in the first line of the display.
1 = Brewing unit in brewing position (brewing position microswitch activated)
2 = Brewing unit in at-rest position (idle position microswitch activated)
3 = Not allocated
4 = HWS valve microswitch activated
5 = Grinds container microswitch activated
6 = Brewing unit microswitch activated
7 = Water tank full (reed contact not activated)
8 = Flow meter pulse
9 = Front door microswitch
0 = Grinder Hall sensor pulses
M = Grinder idle indicator
R = (flashing) Clock function OK
All CPU input signals from the control board appear in the second line of the display.
6 = Espresso
5 = Coffee
4 = Espresso lungo
2 = Powder coffee
3 = Hot water pre-selection
1 = Descale button
7 = Menu/OK

Exit: Switch the machine off at the main switch.

3.2. Diagnosis menu (Incanto de luxe)

The values below can be read and adjusted in the diagnosis menu as shown in the table.

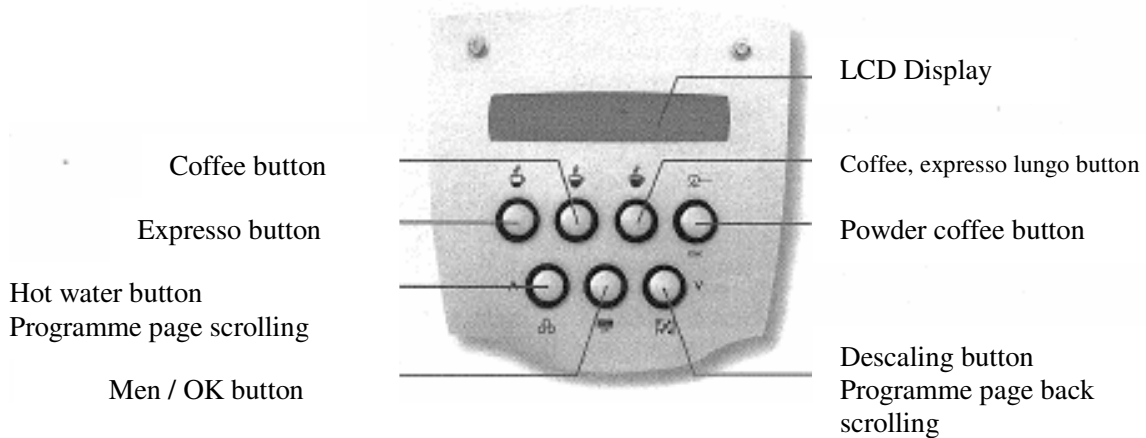

Access: Access from the standby mode (press 2x Menu/OK) by keeping the EXPRESSO, LONG COFFEE and HOT WATER button pressed and pressing the MENU/OK button with a slight delay. (The user programme is also available in this mode.)

Using the ▲ button scroll to the menu item "Diagnosis" and confirm using Menu/OK.

Changing programme values: Access appropriate item using the Menu/OK button.
Change value with ARROW buttons
Save value by using Menu/OK.

Programme table (diagnosis menu):

Function/Standard	Setting range	Increment	Comments
EXPRESSO LUNGO No. of PULSES 600	50 - 1,000 Pulses	+/- 1	Number of flow meter pulses for each saved cup fill volume, where 300 pulses correspond to approx. 100 ml.
EXPRESSO No. of PULSES 200	50 - 1,000 Pulses	+/- 1	
COFFEE No. of PULSES 350	50 - 1,000 Pulses	+/- 1	
----HEATING---- PARAMETER K1 8	1 - 50	+/- 1	Do not change!
----HEATING---- PARAMETER K2 30	1 - 50	+/- 1	Do not change!

Function/Standard	Setting range	Increment	Comments
----HEATING---- SENSOR ADJUST. 96			To adjust processor tolerances. If the temperature in test mode with a set measuring resistance of 3246Ω exceeds or falls short of the specified temperature value (96°C) by more than 1°C, the value indicated in test mode must be applied to adjust the sensor. No measuring resistance: Do not change!
NORMAL TEMP. ° C 90	70- 130°C	+/- 1	Normal temperature is used if not more than 6 min. have elapsed since last coffee dispensed.
HIGH TEMP. ° C 111	70- 130°C	+/- 1	If no coffee is dispensed for an extended time (over 6 min.), the next coffee will be heated to a higher temperature to compensate for cooling of the brewing unit and the associated temperature loss.
TEMP. OF 1st COFFEE ° C 118	70- 130°C	+/- 1	Used when dispensing the first coffee after the machine has been turned on, to compensate for the high temperature loss due to the cold brewing unit and water pipes.
STEAM TEMP. ° C 125	70- 135°C	+/-1	No function
TEMP. INCREASE ° C 0	0-50°C	+/-1	The boiler temperature is increased by a set value shortly before brewing in order to pre-heat the boiler and compensate for the temperature drop during the first water flow.
GRINDS COUNTER Number	0-50	+/-1	Counts number of coffee cycles. When this value reaches the Grinds Stop value, "GRINDS CONTAINER EMPTY" will be displayed. (Reset by removing dregs drawer for emptying - min. 6 sec.)
GRINDS STOP 12	5-50	+/-1	Number of cycles until "EMPTY GRINDS CONTAINER" is displayed.
TOTAL WATER (ml) Number			Total water flow volume (in ml) / not resettable
WATER DESCALING (ml)			Total water flow (in ml) since last descaling / resettable
WATER FILTER (ml) Number	0 - 99999999	+/- 1	Total water flow (in ml) since last filter reset (60,000 - replace filter)

Function/Standard	Setting range	Increment	Comments
Water flow since descaling indicator (ml) Number	0 - 999999999	+/- 1	Water flow since the need for descaling was signalled. (reset via descaling procedure)
HOT WATER FLOW (l/h) 14	6 - 26 l/h	+/- 2 l/h	The pump delivery rate for hot water can be expressed in litres per hour.
HOT WATER PUMP ADJUST. 63000	58,000 - 65,500	+/- 1	The pump delivery rate is adjusted in relation to the HOT WATER FLOW setting by means of a phase controlled modulator. Pump tolerances can thus also be adjusted. An equivalent value is saved under HOT WATER PUMP ADJUSTMENT.
WATER RESERVE COUNTER NUMBER			When the water tank is full, the value from WATER RESERVE STOP is applied. The flow meter pulses are counted from when the reed switch is switched and deducted from the value. If a beverage is chosen for which the saved pulse number is higher than the remaining pulses, the message FILL WATER TANK appears.
WATER RESERVE STOP 420			Water reserve from when the read switch is switched to pulses.
CLEANING CYCLE Counter Number			Counter the cleaning cycles performed.
CLEANING CYCLE Status NUMBER			Status of cleaning programme 0/1 (1= Programme activated)
DESCALING Counter Number			Counter the descaling cycles performed.
DESCALING Status NUMBER			Status of descaling programme 0/1 (1= Programme activated)
MACHINE STATUS 36	0 - 255		Programme code
--DATE OF MANUF---TAG	-----	-----	This date indicates when the machine was manufactured. This date cannot be changed.
--DATE OF MANUF---MONTH	-----	-----	
--DATE OF MANUF---YEAR	-----	-----	
--SERVICE DATE---DAY	0 - 31	+/- 1	The service date indicates the date of the machine's last service. This date can be changed and must be updated at each service.
--SERVICE DATE---MONTH	0 - 12	+/- 1	
--SERVICE DATE---YEAR	1996 - 2050	+/- 1	

Exit: Switch the machine off at the main switch.

4. Service programme (Incanto sirius)

4.1. Test mode

Access: Access the service programme from the standby mode (press MENU/OK) by keeping the EXPRESSO LUNGO and EXPRESSO button pressed, whilst pressing the ON button. If the ON button is released, the current software version is shown.

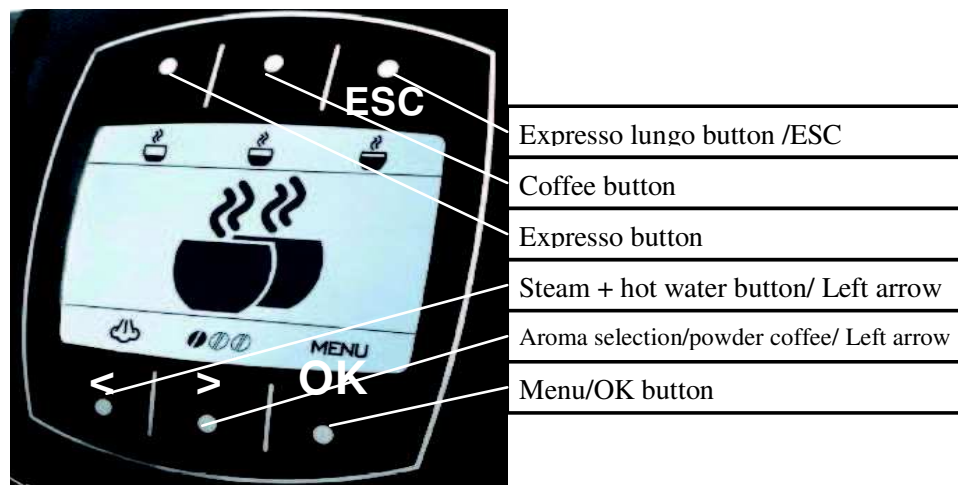

The various functions indicated in the table can be checked by pressing the button combinations listed below.

Programme table (functions programme)

Buttons	S1 Expresso	S2 Coffee	S3 Expresso lungo	S4 Water/stea m	S5 Aroma	S6 Menu/OK
Unit up	x					
Unit down		x				
Grinder			x			
Pump	x					x
Heating plate	x				x	
Heating 1090 W Instantaneous water heater		x			x	
Supplementary heating 437W Gear resistor			x		x	
Pipe heating 1090W				x	x	
Temperature indicator in °C				x	x	x

Display in test mode:

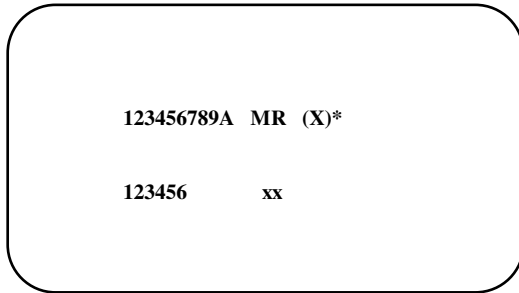

Upper display line:

Indicates the status of the microswitch (see table).

Lower display line:

Indicates the status of the operating buttons.

Flow rate

If the pump is activated during test mode and the hot water valve opened, a two-digit number appears on the bottom right side indicating the flow rate. This value must be between 40 - 60 (should not be below 40).

Grinder power

When the grinder is activated, the grinder power is indicated instead of the flow quantity. Set value: 6-12

Dose quantity base adjustment (X):

A single digit number (X) appears to the extreme right in the top display line. This number indicates the current dose quantity basic setting. The dose quantity base setting can be set at three levels 0,1 and 2.

Aroma pre-selection	Mild	NORMAL	STRONG
Dose quantity base setting 0	90	100	110
Dose quantity base setting 1	95	105	115
Dose quantity base setting 2	100	110	120

Programming: Press S2 (coffee button) and S6 (menu button) simultaneously. An asterisk appears next to the number (x). Press the S2 button repeatedly whilst keeping the S6 button pressed to change the base settings (see table).

Memorise: S3 (expresso lungo) and S6 (menu button).

All CPU input signals from the machine appear in the first line of the display.
1 = Brewing unit in brewing position (brewing position microswitch activated)
2 = Brewing unit in at-rest position (idle position microswitch activated)
3 = Not allocated
4 = HWS valve microswitch activated
5 = Grinds container microswitch activated
6 = Brewing unit microswitch activated
7 = Water tank full (reed contact not activated)

All CPU input signals from the machine appear in the first line of the display.

8 = Flow meter pulses

9 = Front door microswitch

A = Grinder Hall sensor pulses (a "M" appears in idle mode)

M = Grinder idle indicator

R = (flashing) Clock function OK

X = Dose quantity base setting (0, 1, 2)

* = Dose quantity base setting (Access: S2/coffee button + S6/menu button)

All CPU input signals from the control board appear in the second line of the display.

1 = Espresso

2 = Coffee

3 = Espresso lungo

4 = Powder coffee

5 = Hot water pre-selection

6 = Menu/OK button

Exit: Switch the machine off at the main switch.

4.2. Diagnosis menu (Incanto sirius)

The values below can be read and adjusted in the diagnosis menu as shown in the table.

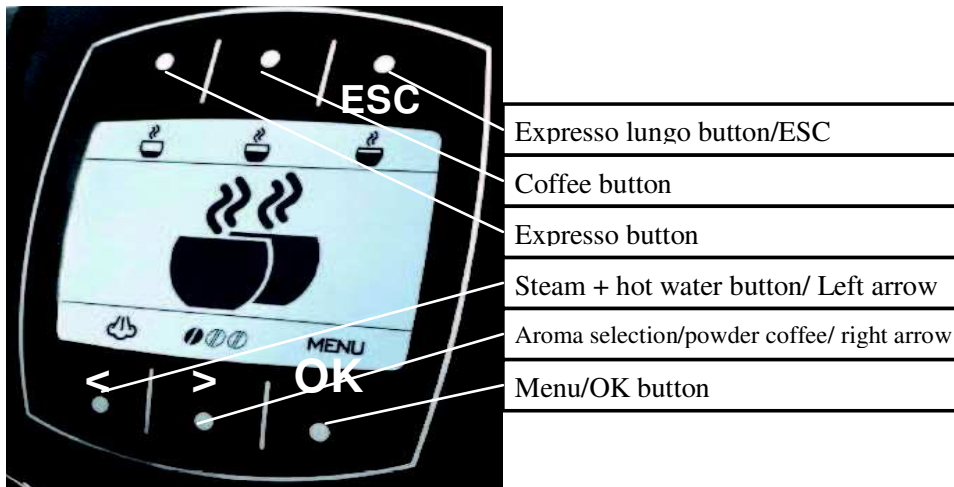

Access: Access from the standby mode (press MENU/OK) by keeping the EXPRESSO and HOT WATER button pressed, whilst pressing briefly the ON button.

From Version: 2.00.1

Access from the standby mode (press MENU/OK) by keeping the EXPRESSO and HOT WATER button pressed, whilst keeping the ON button pressed for an extended time.

Changing programme values: Access appropriate item using the OK button.
Change value with ARROW buttons
Save value by using the OK button.

Programme table (diagnosis menu):

Function/Standard	Setting range	Increment	Comments
EXPRESSO LUNGO No. of PULSES 600	50 - 1,000 Pulses	+/- 1	Number of flow meter pulses for each saved cup fill volume, where 300 pulses correspond to approx. 100 ml.
EXPRESSO No. of PULSES 200	50 - 1,000 Pulses	+/- 1	
COFFEE No. of PULSES 360	50 - 1,000 Pulses	+/- 1	
---HEATING--- PARAMETER K1 8	1 - 50	+/- 1	Do not change!
---HEATING--- PARAMETER K2 30	1 - 50	+/- 1	Do not change!

Function/Standard	Setting range	Increment	Comments
----HEATING---- SENSOR ADJUST 96			To adjust processor tolerances. If the temperature in test mode with a set measuring resistance of 3246Ω exceeds or falls short of the specified temperature value (96°C) by more than 1°C, the value indicated in test mode must be applied to adjust the sensor. No measuring resistance: Do not change!
NORMAL TEMP. ° C 88	70- 130°C	+/- 1	Normal temperature is used if not more than 6 min. have elapsed since last coffee dispensed.
HIGH TEMP. ° C 109	70- 130°C	+/- 1	If no coffee is dispensed for an extended time (over 6 min.), the next coffee will be heated to a higher temperature to compensate for cooling of the brewing unit and the associated temperature loss.
TEMP. 1st COFFEE ° C 117	70- 130°C	+/- 1	Used when dispensing the first coffee after the machine has been turned on, to compensate for the high temperature loss due to the cold brewing unit and water pipes.
TEMP. INCREASE ° C 0	0-50°C	+/-1	The boiler temperature is increased by a set value shortly before brewing in order to pre-heat the boiler. and compensate for the temperature drop during the first water flow.
GRINDS COUNTER Number	0-50	+/-1	Counts number of coffee cycles. When this value reaches the Grinds Stop value, "GRINDS CONTAINER EMPTY" will be displayed. (Reset by removing dregs drawer for emptying - min. 6 sec.)
GRINDS STOP 12	5-50	+/-1	Number of cycles until "EMPTY GRINDS CONTAINER" is displayed.
1 EXPRESSO (ml) Number			Counts number of times espresso is dispensed Not resettable
1 COFFEE (ml) Number			Counts number of times coffee is dispensed Not resettable
1EXPRESSO LUNGO (ml) Number			Counts number of times espresso lungo is dispensed Not resettable

Function/Standard	Setting range	Increment	Comments
TOTAL WATER (ml) Number			Total water flow volume (in ml) / not resettable
WATER DESCALING (ml) Number	0 – 999999999		Total water flow (in ml) since last descaling / resettable
WATER SINCE DESCALING (ml) Number	0 – 999999999		Water flow since the need for descaling was signalled. (reset via descaling procedure) From Version: 2.00.3
NUMBER OF DESCALING PROCESSES: Number			Number of times descaling has been performed (not resettable) From Version: 2.00.3
NUMBER OF CLEANING PROCESSES Number			Number of times cleaning has been performed (not resettable) 2.00.3
WATER FILTER (ml) Number	0 – 999999999	+/- 1	Total water flow (in ml) since last filter reset (60,000 - replace filter)
HOT WATER FLOW (l/h) 18	6 – 34 l/h	+/- 2 l/h	The pump delivery rate for hot water can be expressed in litres per hour.
HOT WATER PUMP ADJUST. 63000	58,000 – 65,500	+/- 1	The pump delivery rate is adjusted in relation to the HOT WATER FLOW setting by means of a phase controlled modulator. Pump tolerances can thus also be adjusted. An equivalent value is saved under HOT WATER PUMP ADJUSTMENT.
WATER RESERVE counter Pulses NUMBER			When the filled water tank is installed, the value changes to the value set for Water Stop (420). When the reed sensor is switched, the flow meter pulses are recorded. If the value is 0 or if a coffee programme has been memorised with a higher pulse number, the signal to fill the water tank will appear.
WATER RESERVE STOP Pulses 420			Residual water quantity determined in terms of pulses from when the reed switch switches, down to the water tank floor.
DESCALING NUMBER			Status of descaling programme 0/1 (1= Programme activated)
CLEANING CYCLE NUMBER			Status of cleaning programme 0/1 (1= Programme activated)

Function/Standard	Setting range	Increment	Comments
MACHINE STATUS	0 - 255		Programme code
--DATE OF MANUF--- DAY	-----	-----	This date indicates when the machine was manufactured. This date cannot be changed.
--DATE OF MANUF--- MONTH	-----	-----	
--DATE OF MANUF--- YEAR	-----	-----	
--SERVICE DATE-- DAY	0 - 31	+/- 1	The service date indicates the date of the machine's last service. This date can be changed and must be updated at each service.
--SERVICE DATE-- MONTH	0 - 12	+/- 1	
--SERVICE DATE-- YEAR	1996 - 2050	+/- 1	

Exit: Press ESC button.

CHAPTER 6

FAULTS

	Page
1. Faults	1

CHAPTER 7

REPAIRS /

SERVICE SCHEDULE

	Page
1. Repairs schedule	1
2. Service schedule	1
3. Final test	2

1. Repairs schedule:

The repairs schedule, together with the service schedule, lists all relevant activities to be performed in an efficient sequence.

	Activity
1	Visual check (transport damage)
2	Record of machine data
3	Functional check / Error analysis (test mode)
4	Opening of machine
5	Visual check (leakages)
6	Mechanical systems check (functional test)
7	Defect detection
8	Modifications check
9	Service operations according to service schedule
10	Internal cleaning
11	Functional test (with open machine / leakage test)
12	Assembly
13	Final test according to test schedule
14	Steam off (winter) - only machines without rapid steam facility
15	External cleaning
16	Lubrication of brewing unit
17	Insulation test (according to the regional test specification)
18	Documentation

2. Service schedule:

Service activities

R = Replace

C = Clean

VC = Visual check

AT = Acoustic test

D = Descale

A = Adjustment

Component	Activity	Equipment
Water filter	C / R	
Lip seal / Water tank	R	
Valve plug O-ring	R	
Valve plug O-ring	R	
Filter (brewing unit)	C / VC	Grease solvent
Hose connections	VC	
Pump	VC / AT	
Gearmotor	AT / VC	
Grinder	C / A	Vacuum cleaner / brush
Water circuit	D	Descaler (Saeco)
HWD valve	VC / R	
Water outlet (valve plug)	C	Grease solvent / brush

3. Final test:

Test	Procedure	Equipment	Instruction	Tolerance
Cup fill volume	2-3 cups on espresso setting	Measuring beaker	Equal quantity	15%
Cup fill volume	2-3 cups on coffee setting	Measuring beaker	Equal quantity	15%
Noise emission			Empirical value Standard noise	
Froth quantity	Carefully froth coffee in cup until froth separates		Froth cover must subsequently close completely	
Froth colour			Textured light brown	
Temperature	Measurement of dispensed coffee stream	Temperature - measuring device	84 °C	± 4 °C
Grind level	Check grain size of coffee grinds		See Training	
Hot water	Dispense hot water			
Steam function	Dispense steam			
Water Low indicator	Remove tank		Fill water tank indicator	
Grinds Container Absent indicator	Remove grinds container		Grinds Container Absent indicator	
Coffee Beans Low indicator	Start coffee programme - coffee bean container empty		Coffee Beans Low indicator	

CHAPTER 8

DISASSEMBLY

	Page
1. Disassembling the cover	1
2. Dismantling of the grinder	3
3. Disassembly of the grinder discs	5
4. Grinder adjustment	7
5. Disassembly of the Grinder	8
6. Disassembly of the display	13
7. Dismantling of the power board	15
8. Dismantling of the support plate	16
9. Dismantling of the pipe heater	18
10. Dismantling of the instantaneous water heater	20
11. Dismantling of the flow meter	23
12. Disassembly of the gear	24
13. Dismantling of the pump	27
14. Adjustment dosage (Incanto Rondo)	29

1. Disassembly of the cover

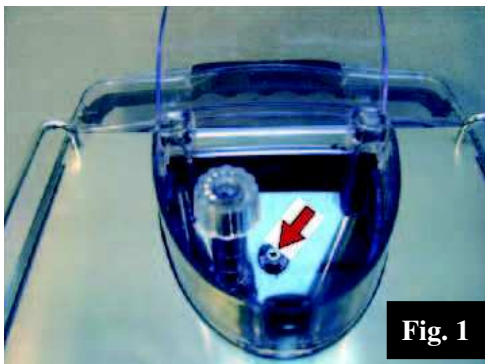

- Remove the screw shown in figure 1 and remove the coffee bean hopper.

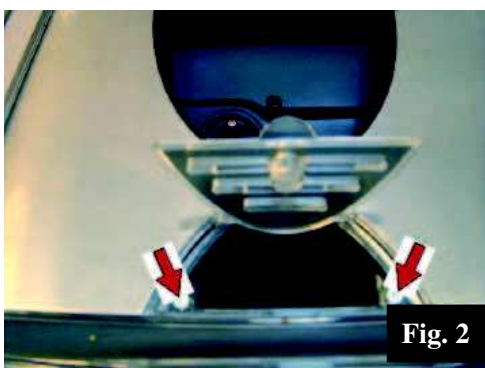

- Unscrew the preground coffee compartment and remove.



- Remove the screws shown in Fig. 3.



- Pull off the hot water/steam knob.

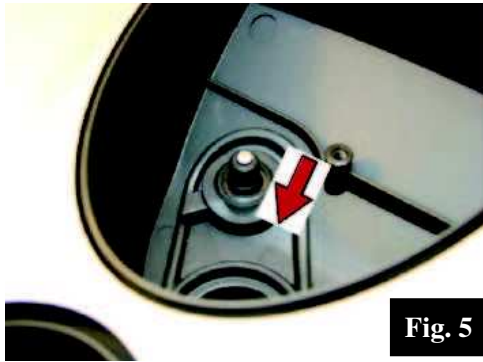

Fig. 5

- Remove the seal.

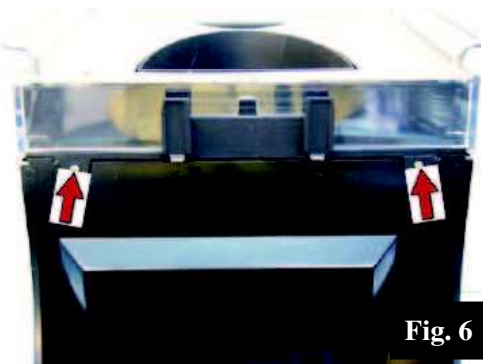

Fig. 6

- Remove the two screws.



Fig. 7

- Remove the cover.

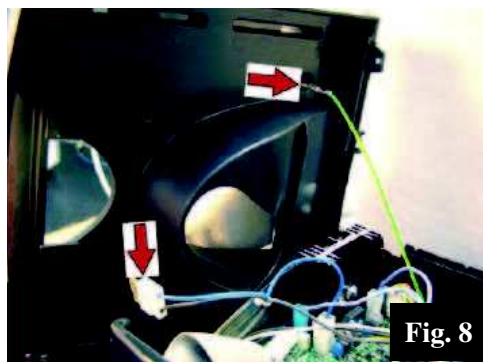

Fig. 8

- Remove the ground connector.
- Remove the cupwarmer connector.

2. Dismantling of the the grinder



- Remove the three screws as shown.



- Remove the clips.

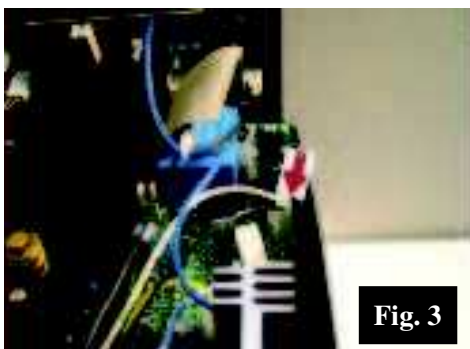

- Remove the connector.

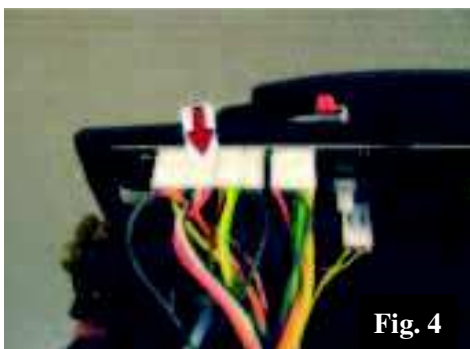

- Remove the connector.

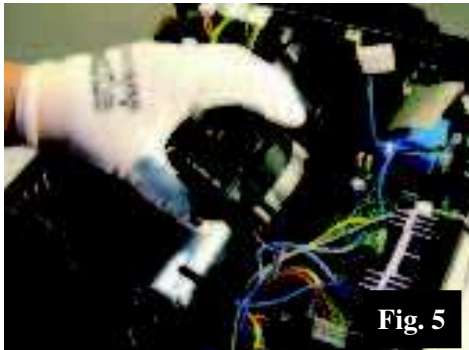
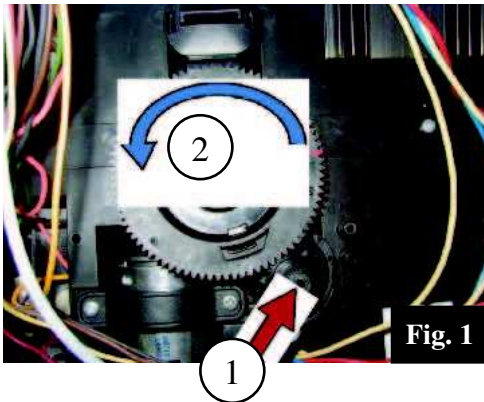

Fig. 5

- Remove the grinder.
- Assemble in reverse order.

3. Disassembly of the the grinder discs



- Press the release button (1) and at the same time turn the ring nut (2) counterclockwise to the end of its stroke and remove the ringnut.



- Remove the grinder disc by means of a small screwdriver, and turn it out of its seats.



- If not possible clean the openings as shown in figure 3.

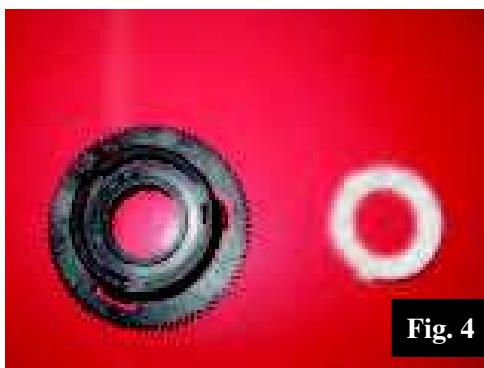

- Removed ceramic grinder disc.

Attention:

- Handle with care, don't drop it

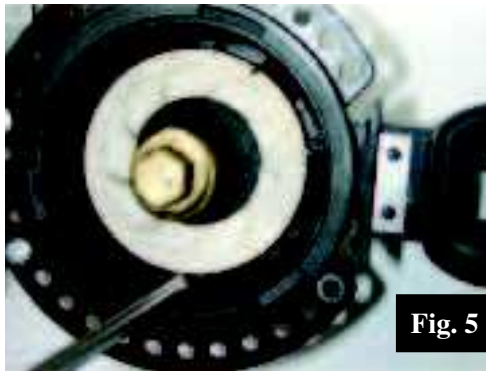

- Remove all the ground coffee by means of a vacuum cleaner.
- Clean also the openings of the three seats, by means of a small screwdriver.

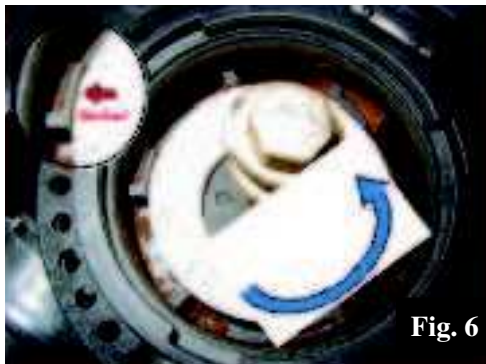

- Turn the grinder disc counterclockwise and unhinge it.



- In case the coffee is pressed very hard, carefully hit the feeder auger, with the knob of a screwdriver, in order to loosen the pressed coffee



- Removed ceramic grinder disc

- **Assembly in reverse order**

4. Grinder adjustment

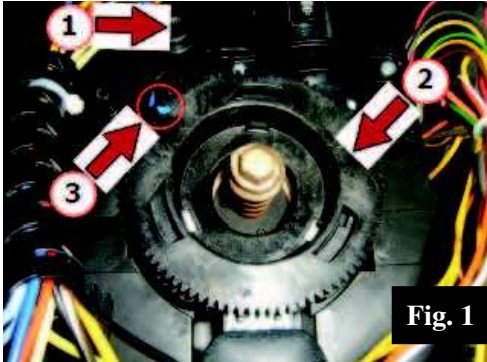

- Insert the ringnut in the same position where its been removed.
- Press the release button and turn it clockwise till the two reference marks match.

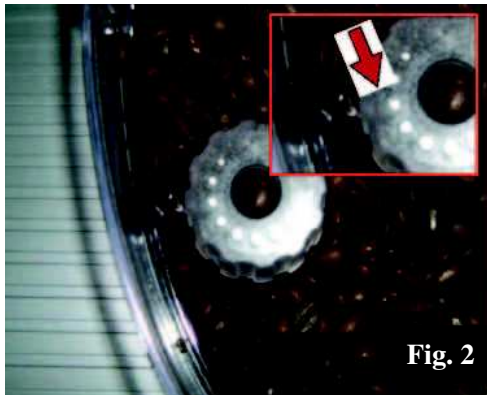

- When attaching the bean hopper ensure, the third small dot of the adjustment knob and the reference pin are matching.

5. Disassembly of the grinder

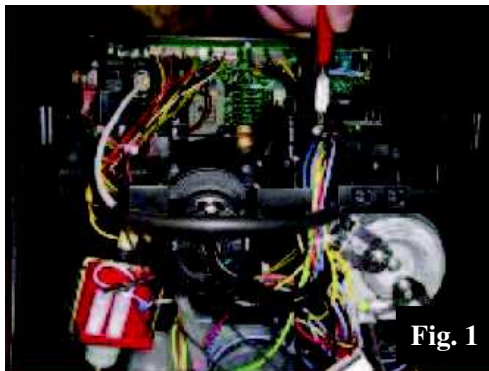

- Cut the relevant clips.

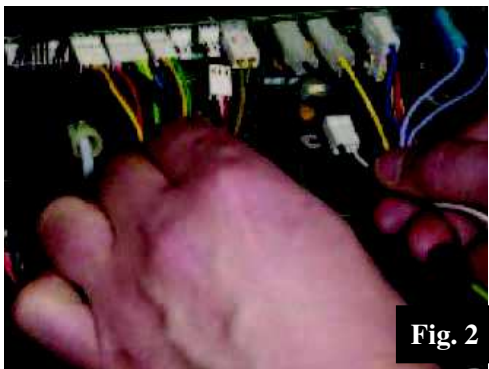

- Remove the connectors.

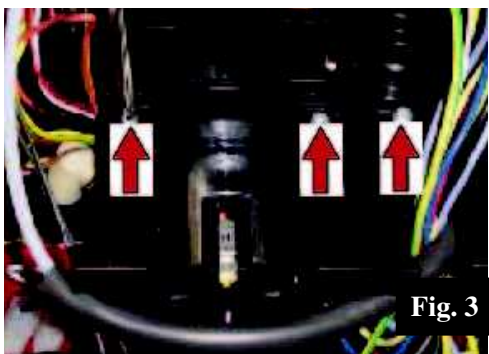

- Remove the three screws.

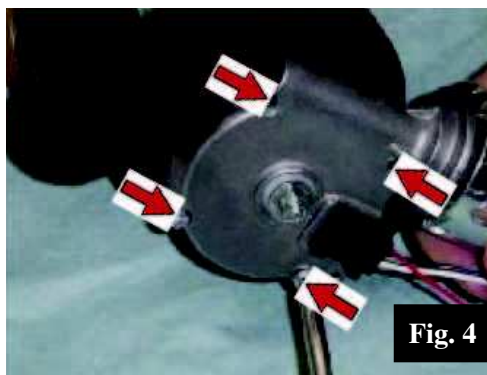

- Remove the four screws, as shown in figure 4

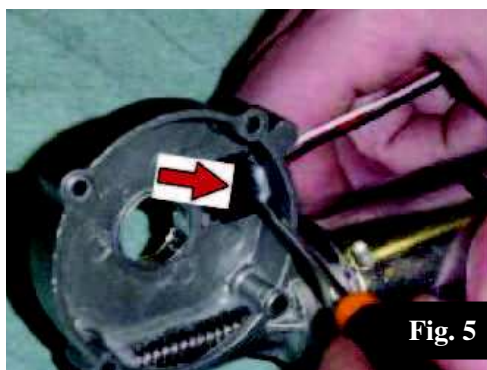

- Remove the sensor, by pressing the anchoring tab by means of a screwdriver.....

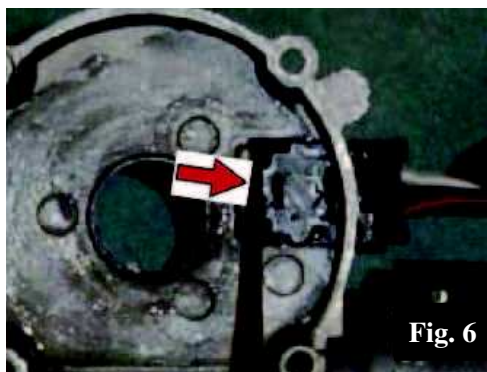

-at the same time remove it from its seat.



- Disconnect the motor power cables.



- Fit the rubber cap to the flange of the new grinder motor.



- Fit the rubber cap to the flange of the new grinder motor.

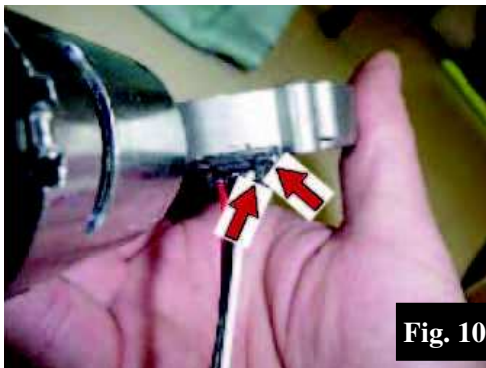

- Insert the sensor removed from the old grinder motor, or if necessary a new sensor into its seat.



- Firmly insert it till the anchoring tab locks the sensor.

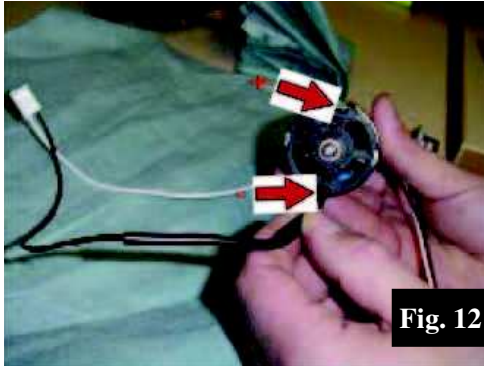

- Connect the the motor to the wiring.
- The black wire has to be connected to (-), the white one has to be connected to (+).

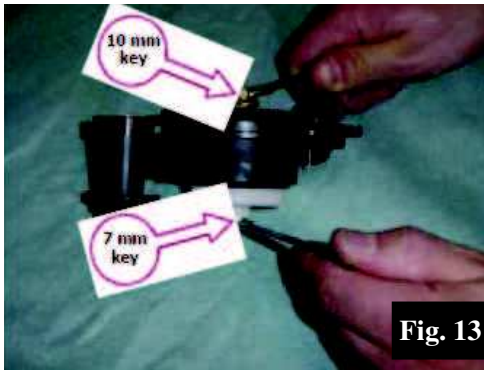

- In case the sprocket is worn out, remove the gear, by means of a 7mm and a 10 mm fork wrench.

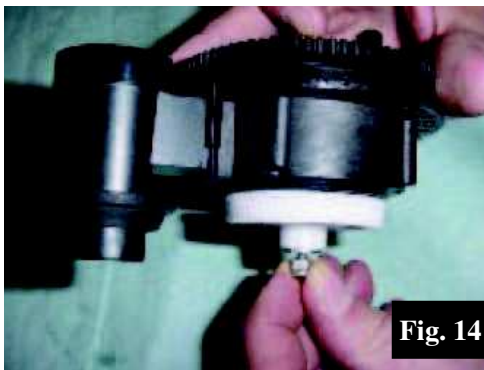

- Exchange the gear.

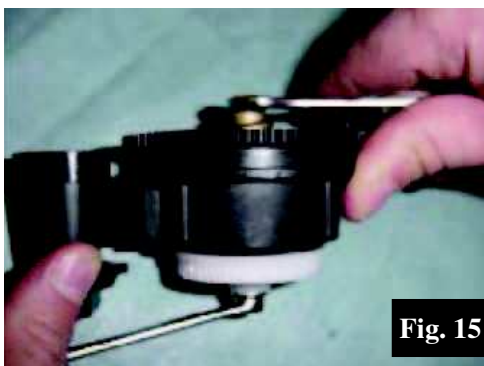

- Fasten it again using the 7mm and 10mm fork wrench.

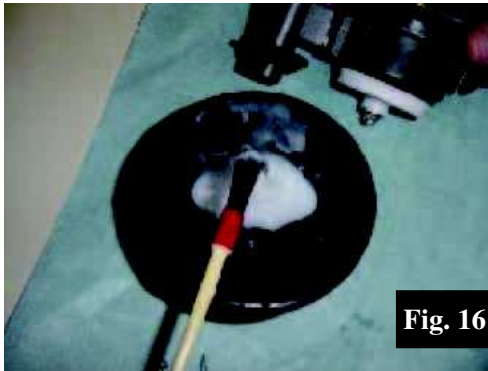

Fig. 16

- Grease the gear.

Attention:

- Use exclusively grease type: “Interflon fin food grease 2”.
Saeco code no. 14-INTEGR22004



Fig. 17

- Grease the sprocket.



Fig. 18

- Grease the worm gear.

Attention:

- Make sure there is no grease on the sensor

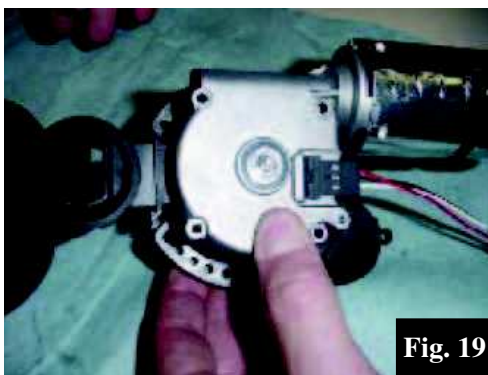
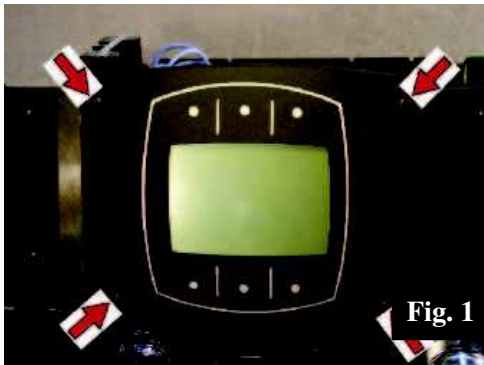

Fig. 19

- Re-assemble.
- Assembly in reverse order

6. Disassembly of the the display



- Remove the four screws.



- Remove the two flat cables.



- Remove the two screws.

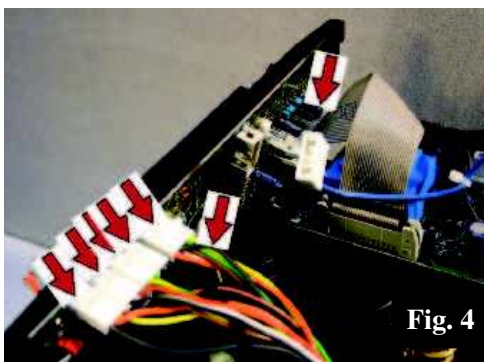

- Remove all connectors of the electronic board.

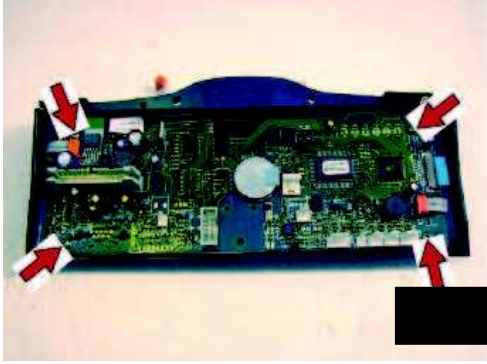

- Remove the four screws, as shown in the figure.

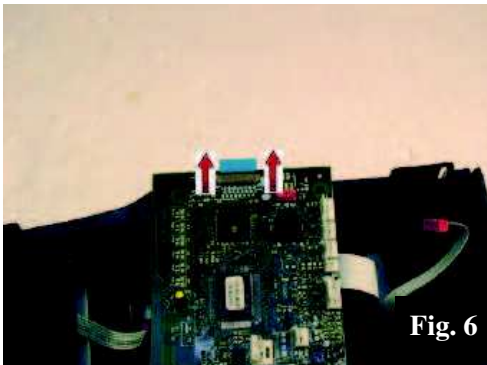

- Remove the blue flat cable as shown in the figure.

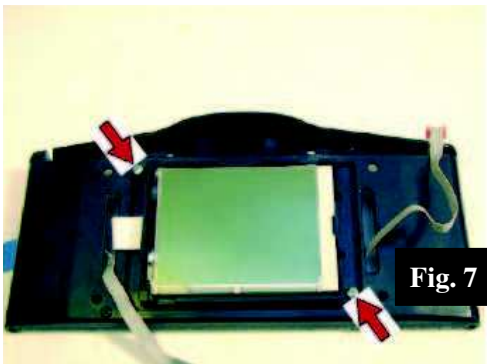

- Remove the two screws as shown in the figure.



- Disassembled parts.

- **Assembly in revers order**

7. Dismantling of the the power board

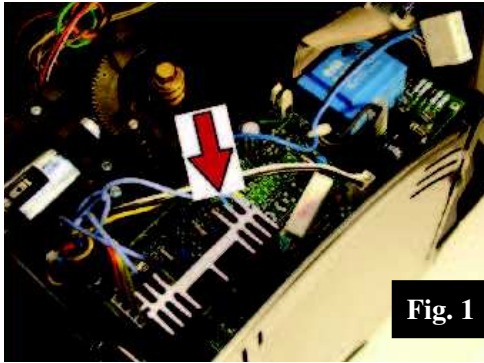

Fig. 1

- Detach all connectors of the power board.

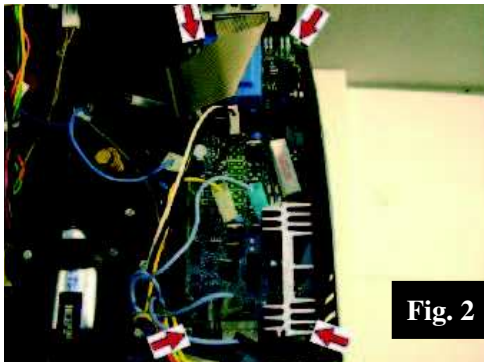
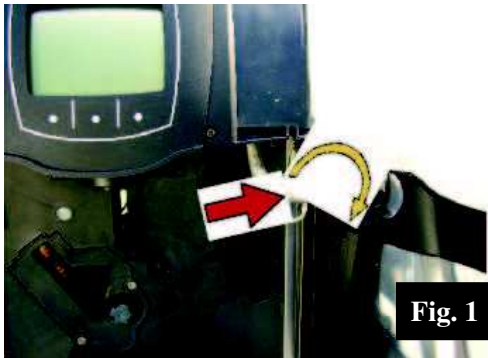

Fig. 2

- Remove the four screws as shown in the figure, and remove the power board.

- Assembly in revers order

8. Dismantling of the the support plate



- Remove the steam tube connection by pulling while rotating counter clockwise.

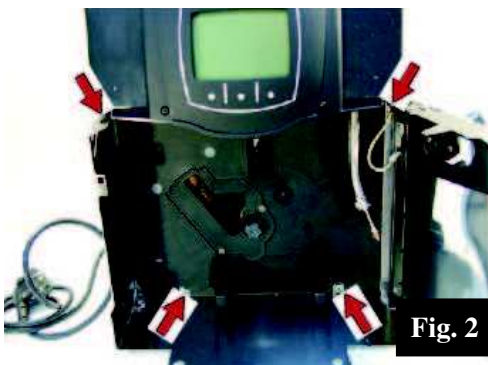

- Remove the four screws, as shown in the figure.

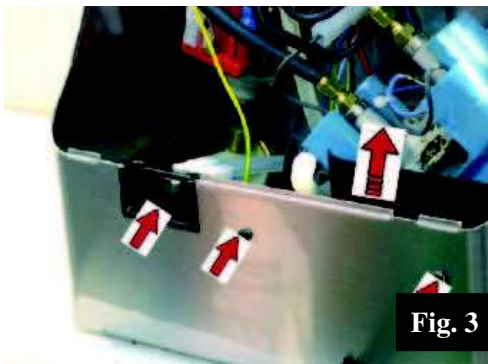

- Pull the switch off the seat and loosen the two screws as shown in the figure.

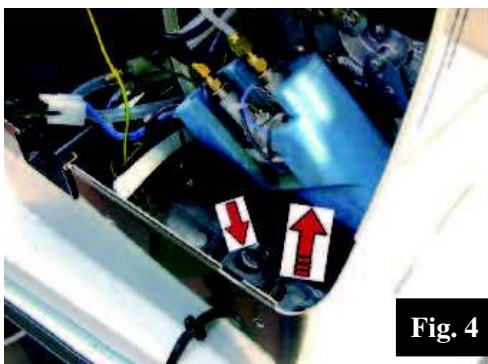

- Remove the cable compartment, as shown in the figure 4.

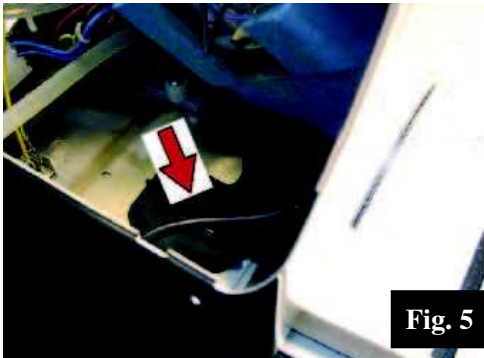

- Remove the grommet, as shown.

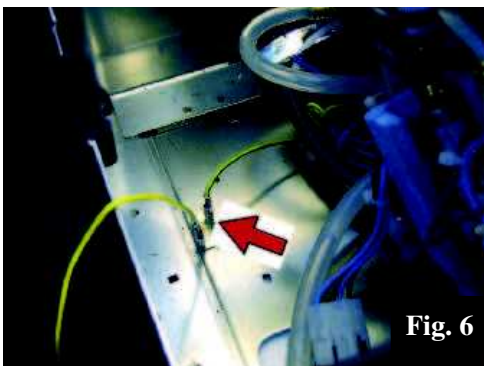

- Remove the ground wire, as shown in the figure.

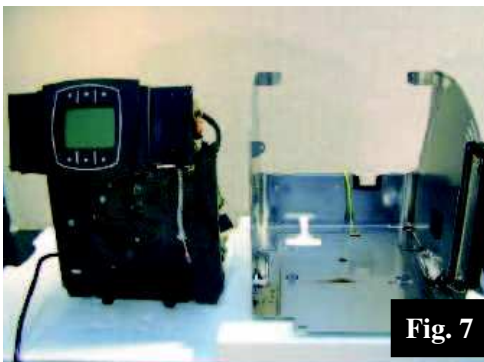

- Remove the assembly plate out of the housing.

- Assembly in revers order

9. Dismantling of the the pipe heater

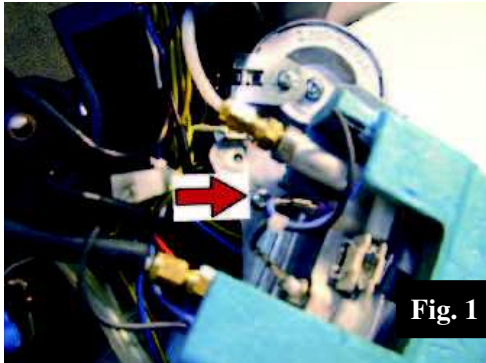

- Remove the screw, as shown in figure 1.

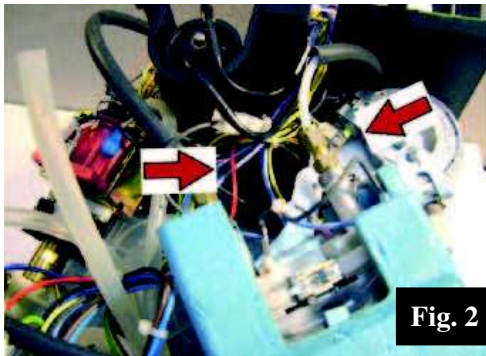

- Remove the two union nuts and remove the two tubes.

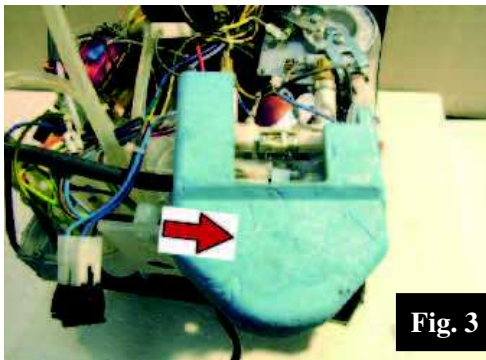

- Remove the thermo isolation of the tube heater.

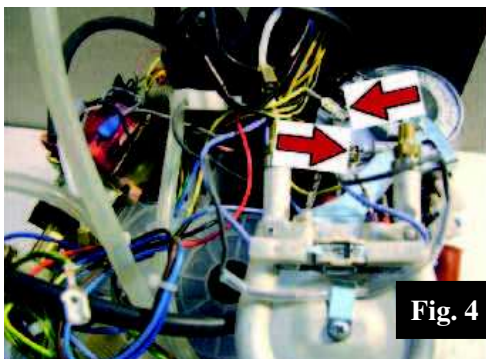

- Remove the two faston connectors.

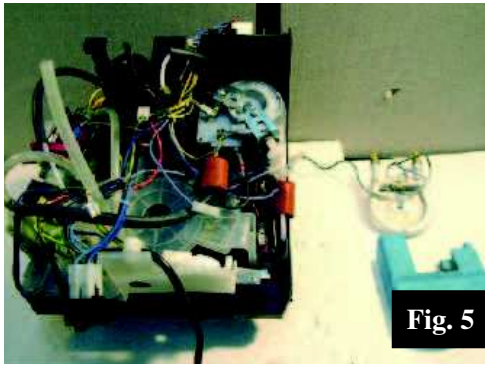
**Fig. 5**

- Dismantled pipe heater.
- **Assembly in revers order**

10. Dismantling of the the instantaneous water heater

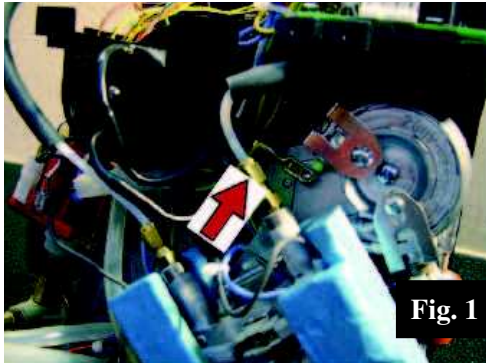

- Remove the union nut, as shown in the figure.

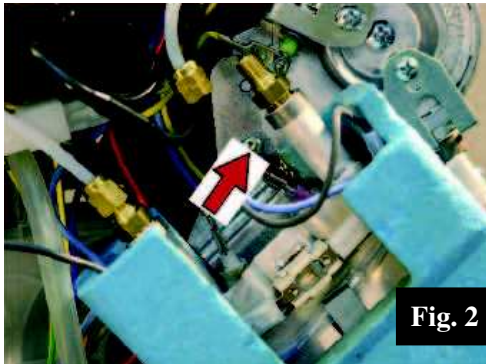

- Remove the mounting screw of the pipe heater.

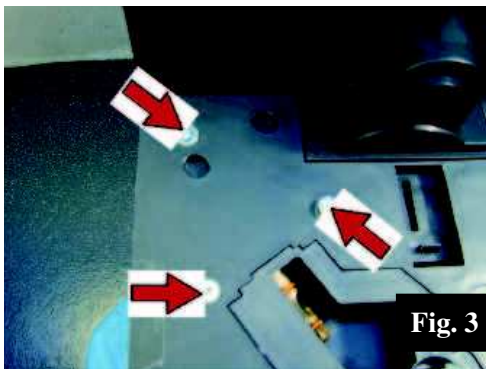

- Remove the three screws, as shown in the figure.

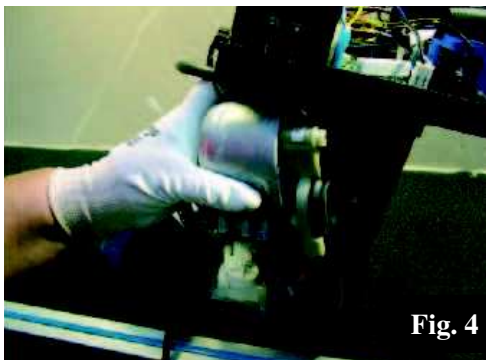

- Remove the heater of the support plate.

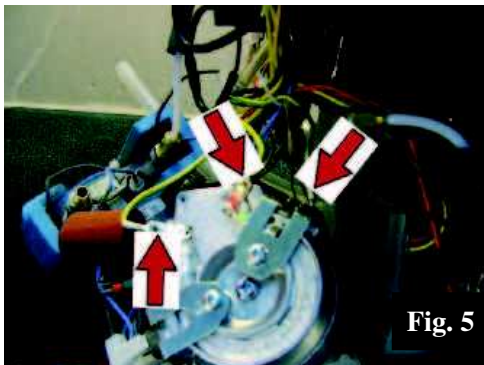

- Remove the three fastener connectors, as shown in figure 5.

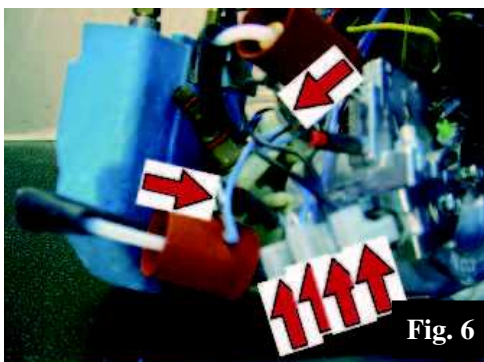

- Remove the fastener connectors, as shown in figure 6.

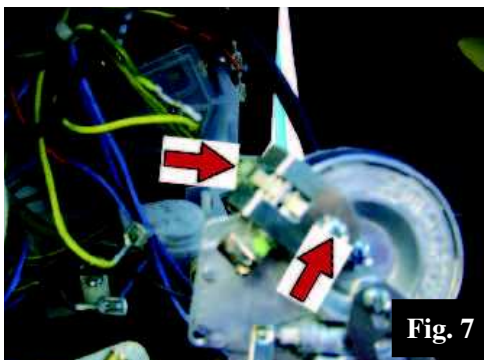

- Remove the mounting screw of the sensor holder and remove the sensor.

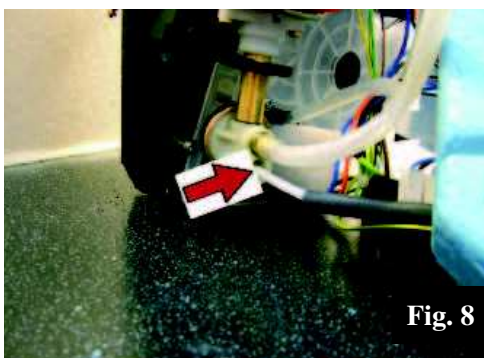

- Remove the locking spring and remove the teflon tube

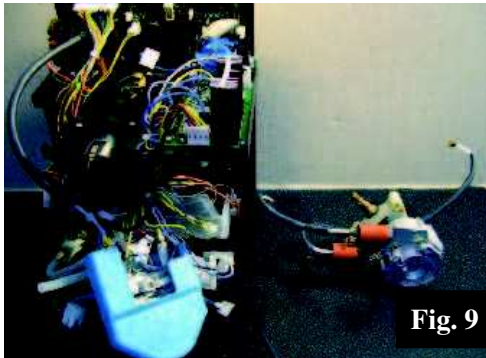

- Dismantled instantaneous water heater.

- Assembly in reverse order

11. Dismantling of the the flow meter

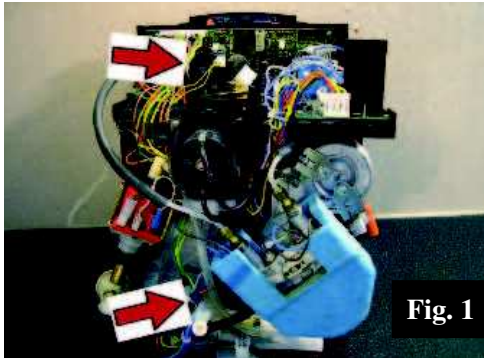

- Remove the two clips, as shown in the figure.

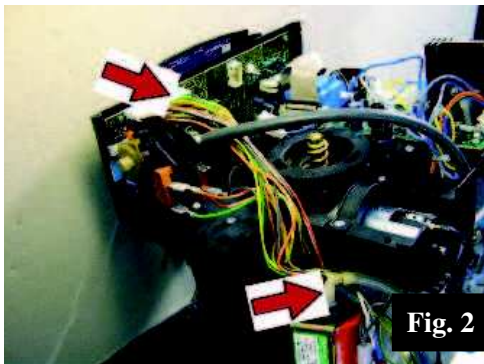

- Remove the flow meter connector from the control board.
- Remove the water hose from the adapter angle of the pump.

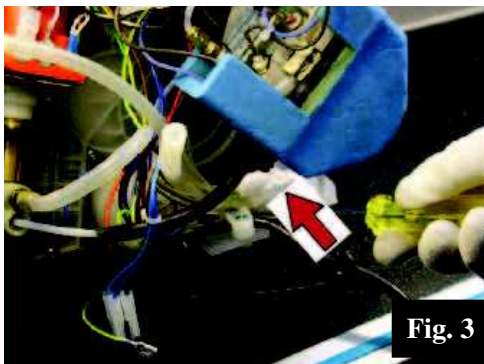

- Remove the flow meter by means of a screwdriver, as shown in figure 3.

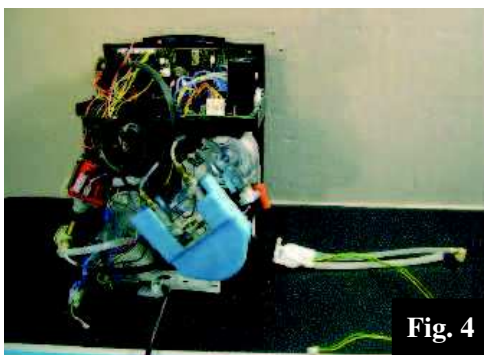

- Dismantled flow meter
- **Assembly in revers order**

12. Disassembly of the the gear

**Fig. 1**

- Remove the three screws, as shown in the figure.

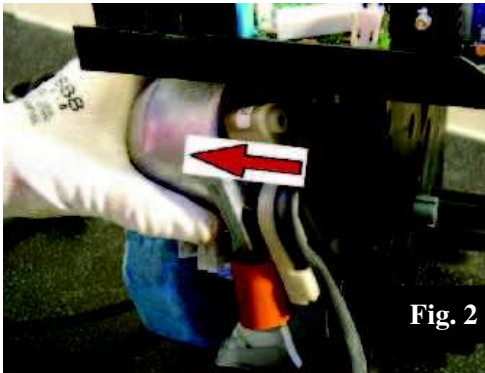
**Fig. 2**

- Remove the instantaneous water heater.

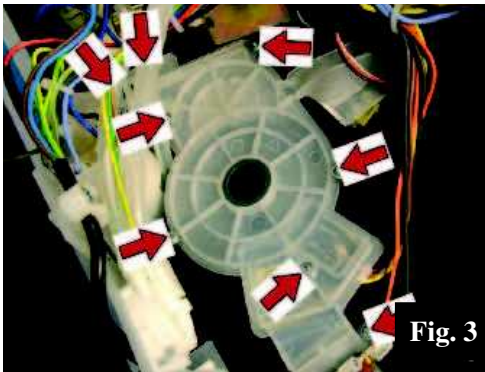
**Fig. 3**

- Remove all the screws from the gear motor cover.

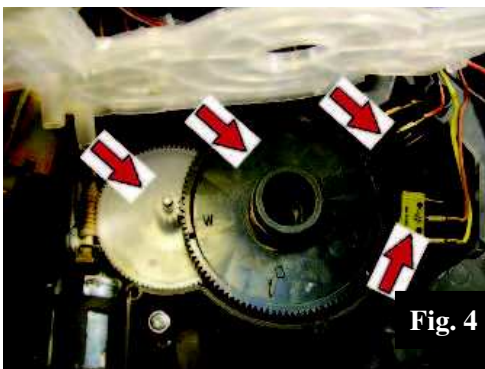
**Fig. 4**

- Remove the two microswitches from their seats.
- Remove both gears.

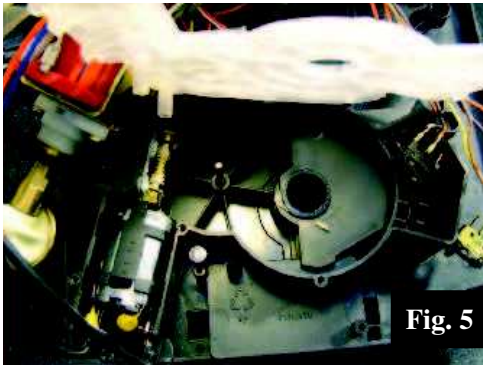

Fig. 5

- Empty gear housing.

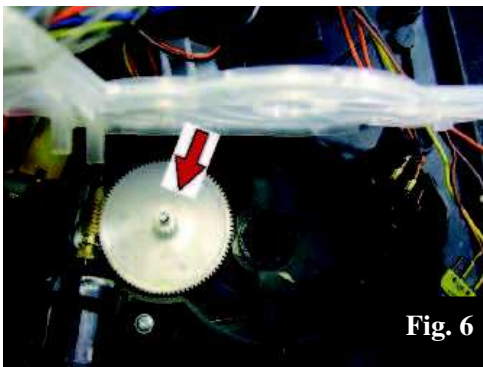

Fig. 6

- Insert the new double toothed gear (in any position).

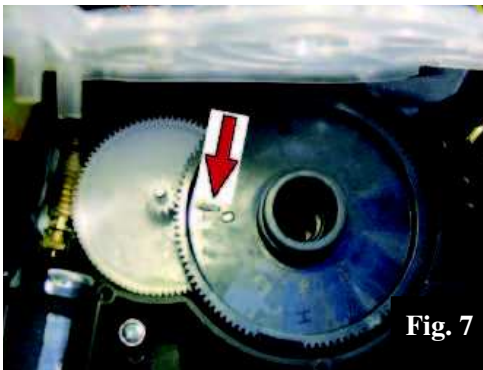

Fig. 7

- Insert the new grey gear.

Attention:

Make sure the arrow is pointing to the axle of the double toothed gear. Before the brew group can be inserted the all components have to be inserted and the machine has to be switched on in order to drive the gear into home position!!!

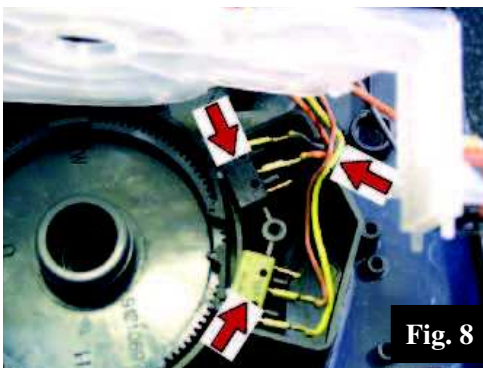
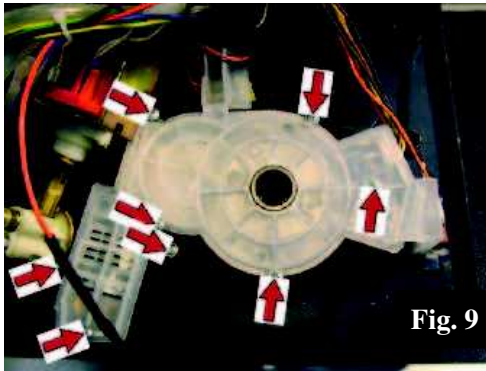

Fig. 8

- Ensure the microswitches and wires are positioned correctly (fig. 12).



- Attach the gear cover and fasten the screws, as shown in figure 13.

- Assembly in revers order

13. Dismantling of the pump

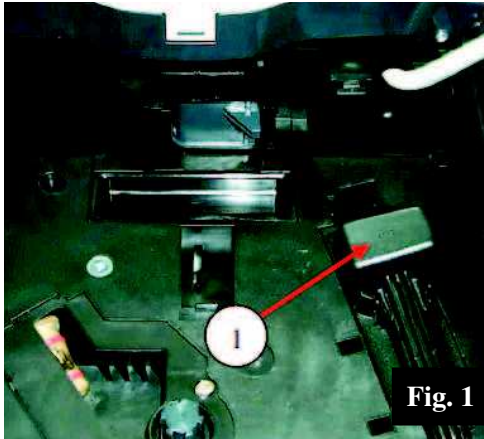

- Remove the measuring scoop.

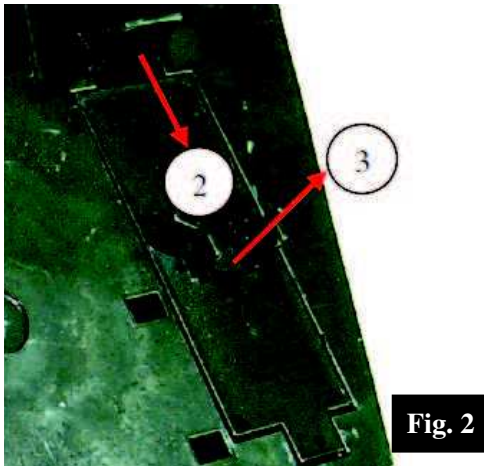

- Pull down the lever (2) and loosen the cover.

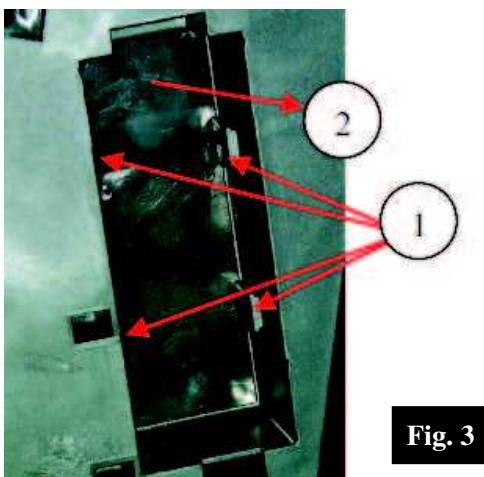

- Unlock the four (three) notches, and remove the locking plate.



Fig. 4

- The pump supports are now unlocked.

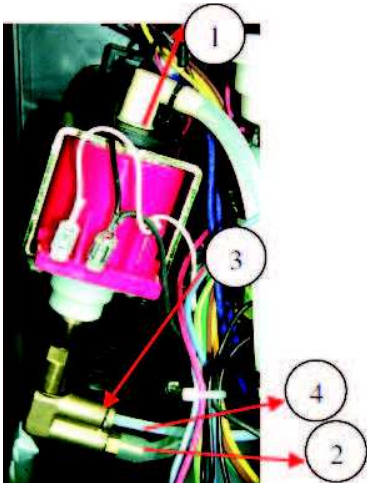

Fig. 5

- Remove the adapter angle (1)
- Remove the water hose (2)
- Remove the locking spring (3)
- Remove the teflon tube (4)

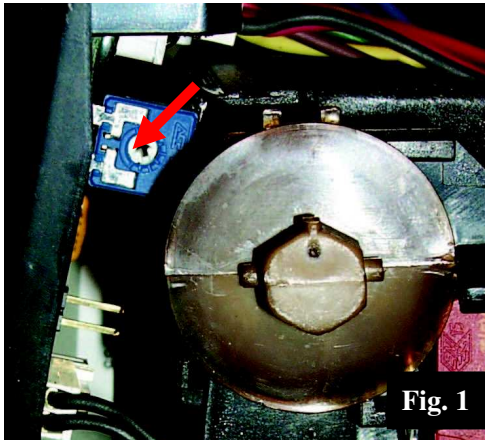

Fig. 6

- Separate the upper Pump support (1) from the pump and the lower pump support (2) from the support plate.

- **Assembly in revers order**

4. Adjustment dosage (Incanto rondo)



- Remove the HWS-knob and adjust the dosage as follows:
Rotation counterclockwise decreases dosage (min 6 grammes)
Rotation clockwise increases the dosage (max 10,5 grammes).

CHAPTER 9

CIRCUIT DIAGRAMS

**INCANTO EASY
INCANTO
INCANTO RAPIDSTEAM
INCANTO DIGITAL
INCANTO DIGITAL SBS**

SERVICE MANUAL

Revision: 5

Saeco

Saeco International Group

FEB.: 2005

All parts of the present service manual are the property of Saeco International Group. All rights reserved. The manufacturer is not responsible for any errors or omissions in the present document. Any reproduction or unauthorised use of this manual without the prior written permission of the manufacturer or by contractual agreement is prohibited.

Table of contents

- 1. Introduction**
- 2. Technical data**
- 3. Operation**
- 4. Functions and timing**
- 5. Service programme**
- 6. Faults**
- 7. Fault diagnosis**
- 8. Repairs / Service Schedule / Final Test**
- 9. Disassembly**
- 10. Circuit diagrams**

CHAPTER 1

INTRODUCTION

	Page
1. Documents required	1
2. Equipment	1
3. Material	1
4. Safety instructions	1
5. Overview of product range	2

1. Requirements for operation

- Service manual
- Operating instructions where available

2. Equipment

In addition to an electrical workshop, the following standard tools are necessary:

Qty	Description	Comments
1	Special screwdriver (Pozi)	Size: PZ1
1	Special screwdriver (Pozi)	Size: PZ2
1	Temperature measuring device	Temperature range > 200°C Suitable for point measurements

3. Material

Description	Comments	Brand
Heat conductive paste	Temperature resistance ≥ 2	User's choice
Bolt adhesive	Temperature resistance ≥ 2	User's choice
Descaler		Saeco
Grease solvent		User's choice
Silicone grease (food safe)		Saeco

4. Safety instructions

All prescriptions and regulations in force regarding the repair of electrical equipment must be observed!

The machine must be disconnected from the main power supply before performing repair work. Switching the machine off is not an adequate measure.

The Incanto coffee machine is classified under Protection Class 1. Protective devices must be tested once the repair work has been completed (HG 701).

5. Overview of product range



Incanto Digital



Incanto/ Incanto rapid steam

	Pre-brewing Pre-grinding	Rapid steam	Powder coffee compartment	Cup warmer	Display	SBS
INCANTO Easy	Pre-brewing					
INCANTO	x					
INCANTO rapid steam	x	x	x	x		
INCANTO rapid steam SBS	x	x	x	x		x
INCANTO digital	x	x	x	x	x	
INCANTO digital SBS	x	x	x	x	x	x

CHAPTER 2

TECHNICAL DATA

	Page
1. Technical Data (Incanto/Easy)	1
2. Technical Data (Incanto Rapid Steam)	2
3. Technical Data (Incanto Digital/Digital SBS)	3

1. Technical Data (Incanto, Incanto Easy)

INCANTO / INCANTO Easy	
Technical data	
Power supply/output:	230V 50Hz 1250W
Safety system:	170°C Safety thermostat for instantaneous water heater
Temperature monitoring:	KTY Temperature sensors transmit respective temperatures to electronic system
Continuous flow thermoblock:	Instantaneous water heater (1090 W) for coffee, hot water and steam dispensing.
Pump:	Ulka reciprocating piston pump, 230V, 50 Hz, 48 W, Type EX5, 20 l/h
Safety valve:	Conventional safety valve (17 bar) connected directly to pump.
Water filter:	In water tank, installed at outlet.
Gearmotor:	Direct current, 30 - 35 V
Gear resistor:	Approx. 437W / 130Ω
Cup warmer	-
Grinder (conical):	Plastic grinding screw, galvanised steel grinding cone and grinding disc
Grinder motor:	260 V Direct current
Second Doser:	230 V - Magnet coil
Power consumption:	During heating - approx. 4.5 A
Pump pressure:	Max. 15 bar
Dimensions W x D x H in mm:	265/400/360
Weight:	Approx. 10kg
Coffee bean container capacity:	Approx. 180g
Water tank capacity:	Approx. 1.7l max.
Instantaneous water heater capacity:	Approx. 1.0 ccm, 10 ml volume
De-aeration time:	Approx. 10 for initial start-up
Heating time:	Approx. 1.5 min
Steam heating time:	From coffee temperature to 127°C - Approx. 50 sec.
Coffee dispensing temperature:	Approx. 86° C
Grinding time:	Initial grinding with completely empty machine: Approx. 15 sec. / each subsequent grinding: approx. 4-6 sec.
Time to make espresso:	Approx. 28 sec. for 50 ml
Time to make cup of coffee:	Approx. 40 sec. for 100 ml

2. Technical Data (Incanto Rapid Steam)

INCANTO RAPID STEAM	
Technical data	
Power supply/output:	230V 50Hz 1250W
Safety system:	170°C Safety thermostat for instantaneous water heater
Temperature monitoring:	KTY Temperature sensors transmit respective temperatures to electronic system
Continuous flow thermoblock:	Instantaneous water heater (1090 W) for coffee and hot water dispensing
Pipe heating:	1000W – Steam dispensing (rapid steam)
Pump:	Ulka reciprocating piston pump, 230V, 50 Hz, 48 W, Type EX5, 20 l/h
Safety valve:	Conventional safety valve (17 bar) connected directly to pump.
Water filter:	In water tank, installed at outlet.
Gearmotor:	Direct current, 30 - 35 V
Gear resistor	Approx. 437W / 130Ω
Cup warmer	PTC - Approx. 30 W at operating temperature (approx. 60°C)
Grinder (conical):	Plastic grinding screw, galvanised steel grinding cone and grinding disc
Grinder motor:	260 V Direct current
Second Doser:	230 V - Magnet coil
Power consumption:	During heating - approx. 4.5 A
Pump pressure:	Max. 15 bar
Dimensions W x D x H in mm:	265/400/360
Weight:	Approx. 10.5 kg
Coffee bean container capacity:	Approx. 180g
Water tank capacity:	Approx. 1.7l max.
Instantaneous water heater capacity:	Approx. 1.0 ccm, 10 ml volume
De-aeration time:	Approx. 10 for initial start-up
Heating time:	Approx. 1.5 min. with water at 10°C to operating temperature
Steam heating time:	From coffee temperature to 127°C - Approx. 50 sec.
Coffee dispensing temperature:	Approx. 86° C
Grinding time:	Initial grinding with completely empty machine. Approx. 15 sec. / each subsequent grinding: approx. 4-6 sec.
Time to make espresso:	Approx. 28 sec. for 50 ml
Time to make cup of coffee:	Approx. 40 sec. for 100 ml

3. Technical Data (Incanto Digital / SBS)

INCANTO DIGITAL / SBS	
Technical data	
Power supply/output:	230V 50Hz 1250W
Safety system:	170°C Safety thermostat for instantaneous water heater
Temperature monitoring:	KTY Temperature sensors transmit respective temperatures to electronic system
Continuous flow thermoblock:	Instantaneous water heater (1090 W) for coffee and hot water dispensing
Pipe heating:	1000W – Steam dispensing (rapid steam)
Pump:	Ulka reciprocating piston pump, 230V, 50 Hz, 48 W, Type EX5, 20 l/h
Safety valve:	Conventional safety valve (17 bar) connected directly to pump.
Water filter:	In water tank, installed at outlet.
Gearmotor:	Direct current, 30 - 35 V
Gear resistor	Approx. 437W / 130Ω
Cup warmer	PTC - Approx. 30 W at operating temperature (approx. 60°C)
Grinder (conical):	Plastic grinding screw, galvanised steel grinding cone and grinding disc
Grinder motor:	260 V Direct current
Second Doser:	230 V - Magnet coil
Power consumption:	During heating - approx. 4.5 A
Pump pressure:	Max. 15 bar
Dimensions W x D x H in mm:	265/400/360
Weight:	Approx. 10.5 kg
Coffee bean container capacity:	Approx. 180g
Water tank capacity:	Approx. 1.7l max.
Instantaneous water heater capacity:	Approx. 1.0 ccm, 10 ml volume
De-aeration time:	Approx. 10 for initial start-up
Heating time:	Approx. 1.5 min. with water at 10°C to operating temperature
Steam heating time:	From coffee temperature to 127°C - Approx. 50 sec.
Coffee dispensing temperature:	Approx. 86° C
Grinding time:	Initial grinding with completely empty machine. Approx. 15 sec. / each subsequent grinding: approx. 4-6 sec.
Time to make espresso:	Approx. 28 sec. for 50 ml
Time to make cup of coffee:	Approx. 40 sec. for 100 ml

CHAPTER 3

OPERATION

	Page
1. Operation (Incanto)	
1.1. Control panel	1
1.2. Operating instructions	1
1.3. User programme	4
2. Operation (Incanto Rapid Steam)	5
2.1. Control panel	5
2.2. Operating instructions	5
2.3. User programme	8
3. Operation (Incanto Digital/Digital SBS)	9
3.1. Control panel	9
3.2. Operating instructions	9
3.3. User programme	12
4. Operation (Incanto Easy)	14
4.1. Control panel	14
4.2. Operating instructions	14

1. Operation (Incanto)

1.1 Control panel

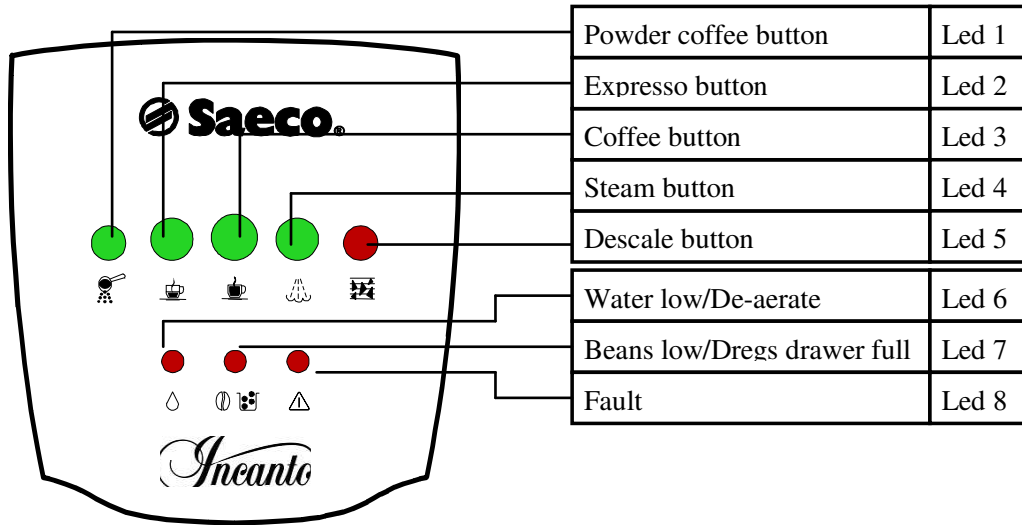

1.2. Operating instructions (quick reference)

	Action	Comments	Powder button LED	Espresso LED	Coffee LED	Steam LED
Getting started						
1	Unpack machine.	Check for damage.				
2	Fill water tank.					
3	Fill coffee beans container.					
4	Connect mains plug.					
5	Turn on main switch.			Light flashing	Light flashing	
6	De-aerate water circuit.	Open hot water pressure valve until water flows.		Light flashing	Light flashing	
		Heating stage (approx. 1.5 min).		Light flashing	Light flashing	
		Ready		ON	ON	
Making coffee						
7	Programme coffee quantity for each selection button. <ul style="list-style-type: none"> • Coffee • Espresso 	Depending on cup size. Programme by keeping the coffee selection button pressed until the desired quantity is reached.		Light flashing	Light flashing	
8	Place cup under dispenser.					
9	Press start button (coffee button).	Press once = 1 cup of coffee		Light flashing	(flashes)	
		Press twice = 2 cups of coffee.		Light flashing 2 x interval	(flashes) 2 x interval	

	Action	Comments	Powder button LED	Espresso LED	Coffee LED	Steam LED
	Coffee dispensing / Powder coffee					
10	Place cup under dispenser.	Place powder coffee in powder container (1 measuring spoonful)				
11	Select powder button and relevant coffee button: Espresso / Coffee	Only one coffee can be dispensed at a time.	ON	Light flashing	(flashes)	
	Dispensing steam					
12	Press steam button.	Heating stage.				Light flashing
13		Ready				ON
14	Steam dispensing. Open HWS valve	To warm coffee. To froth milk.				ON
15	Press steam button / deactivate steam function.	Cool by de-aerating.		Light flashing	Light flashing	Light flashing
		Ready (to make coffee)		ON	ON	
	Hot water dispensing					
16	Open HWS valve	Immediate		ON	ON	

Cleaning		
	Empty dregs drawer	Storage capacity of 13 tablespoons (Reset - empty only when indicated and with machine on)
	Empty drip tray	As required
	Clean water tank	As required
	Clean coffee bean container	As required
	Clean the housing	As required
	Rinse brewing unit	As required
	Clean brewing unit and lubricate	1 x per month
	Clean filter	
	Descaling	According to indicator

Descaling frequency		
	Water hardness	Descaling frequency
	Very hard water (over 21°dH)	About every 4 weeks
	Hard water (15°-21°dH)	About every 6 weeks
	Medium water (15°-21°dH)	About every 2 months
	Soft water (up to 7°dH)	About every 3 months
	Or when the descaling indicator flashes.	

Descaling procedure		
Action	Comments	Descal LED indicator
Descaling	Fill water tank with commercial descaler according to the relevant instructions.	Light flashes
	Place an appropriately sized container under the HWS nozzle.	Light flashes
Keep the descaling button pressed for about 5 sec.	Descaling programme is activated.	ON
Open HWS valve	The pipes are rinsed with descaler at intervals. (Duration: approx. 45 min)	Light flashes
Programme end		LED of all 5 buttons flash
Close HWS valve	Descaling programme complete.	Off
Rinse (fill tank 2x)	Open HWS valve	Off
Troubleshooting		
Fault	Remedy	
No display No power supply to machine.	Check mains fuses / Is machine plugged in? / Is main switch turned on?	
Water instead of coffee (powder button pressed)	- Place a measuring spoonful of coffee powder in the powder compartment	
Coffee is not hot enough	- Pre-heat cups	
	- Clean brewing unit if necessary	
	- Descale if necessary	
No hot water/steam Hot water/steam nozzle blocked	- Clean nozzle out with needle (with machine turned off and closed rotary valve/HWS valve).	
Heating time too long, water quantity insufficient	- Descale machine	
The brewing unit cannot be removed.	- Close service door. - Turn machine on (brewing unit moves to home position)	
The brewing unit cannot be removed.	- Bring brewing unit to initial position.	
Cannot dispense		
The descaling indicator flashes (machine not locked)	- Descale	
Espresso, coffee and steam buttons flash	- Overheating: Remove hot water until only espresso and coffee buttons are lit	
Water LED lights up	- Fill with fresh water	
Water LED flashes	- De-aerate machine	
Coffee beans/Dregs LED lights up	- Fill with coffee beans	
Coffee beans/grinds container LED flashes	- Empty grinds container (machine must be turned on)	
Warning LED lights up	- Correctly install brewing unit, drip tray and grinds container.	
Warning LED flashes	- Grinder obstructed - Gears obstructed - Contact an authorised service centre	

1.3. User programme (Incanto)

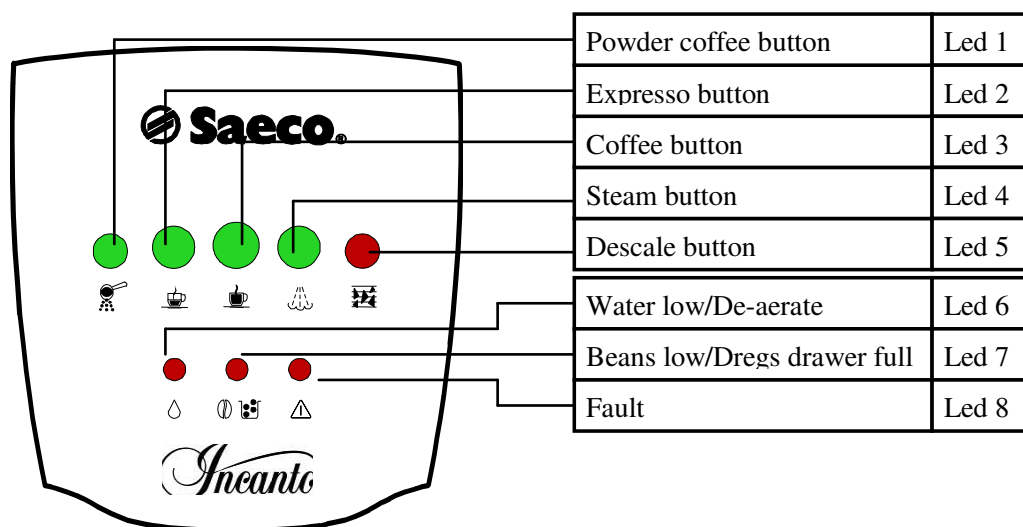

The table below indicates the various settings and programmes which can be selected through the user programme options.

Access: The machine must be turned on with the espresso and steam buttons pressed in order to enter the programming mode.

Function	Button	Status	LED indicator
Water hardness setting for descaling indicator	Powder coffee (Press to activate an additional LED and then change descaling interval.)	0 – very soft water (0° - 3°dH) 1000 l	Led: 1
		1 – soft water (4° - 7°dH) 500 l	Led: 1+2
		2 – medium water (7°-14°dH) 300 l	Led: 1+2+3
		3 – hard water (14°-21°dH) 150 l	Led: 1+2+3+4
		4 – very hard water (over 21°dH) 80 l	Led: 1+2+3+4+5
Rinse programme	Espresso	ON/OFF (LED lit up means programme activated)	Water Low LED
Pre-brewing	Coffee	ON/OFF (LED lit up means programme activated)	Coffee Beans Low LED
Pre-grinding	Steam	ON/OFF (LED lit up means programme activated)	Fault LED

2. Operation (Incanto Rapid Steam)

2.1 Control panel

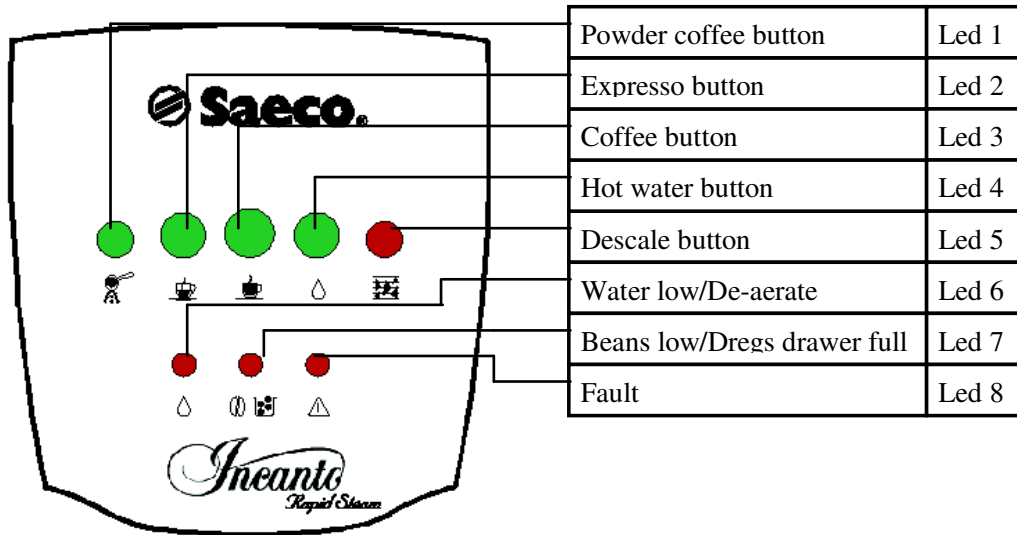

2.2. Operating instructions (quick reference)

	Action	Comments	Powder button LED	Espresso LED	Coffee LED	Hot water LED
Getting started						
1	Unpack machine	Check for damage				
2	Fill water tank					
3	Fill coffee beans container					
4	Connect mains plug					
5	Turn on main switch			Light flashes	Light flashes	
6	De-aerate water circuit	Press hot water button Open hot water pressure valve until water flows.		Light flashes	Light flashes	Light on
		Heating stage (approx. 1.5 min)		Light flashes	Light flashes	
		Ready		ON	ON	
Making coffee						
7	Programme coffee quantity for each selection button • Coffee • Espresso	Depending on cup size. Programme by keeping the coffee selection button pressed until the desired quantity is reached.		Light flashes For espresso programming	Light flashes For coffee programming	
9	Press start button (coffee button)	Press once = 1 cup of coffee		Light flashes	(flashes)	
		Press twice = 2 cups of coffee.		Light flashes 2 x interval	(flashes) 2 x interval	

	Action	Comments	Powder button LED	Espresso LED	Coffee LED	Steam LED
	Coffee dispensing / Powder coffee					
10	Place cup under dispenser	Place powder coffee in powder container (1 measuring spoonful)				
11	Select powder button and relevant coffee button: Espresso / Coffee	Only one coffee can be dispensed at a time	ON	Light flashes	(flashes)	
	Dispensing steam					
12	Open HWS valve	Immediately ready		ON	ON	
	Hot water dispensing					
13	Press hot water button	Immediately ready		ON	ON	ON
14	Open HWS valve	Water removed		ON	ON	ON
15	Close HWS valve	Water removal complete		ON	ON	ON
16	Press hot water button	Steam mode		ON	ON	Off

Cleaning		
	Empty dregs drawer	Storage capacity of 13 tablespoons (Reset - empty only when indicated and with machine on)
	Empty drip tray	As required
	Clean water tank	As required
	Clean coffee bean container	As required
	Clean the housing	As required
	Rinse brewing unit	As required
	Clean brewing unit and lubricate	1 x per month
	Clean filter	
	Descaling	According to indicator

Descaling frequency	
Water hardness	Descaling frequency
Very hard water (over 21°dH)	About every 4 weeks
Hard water (15°-21°dH)	About every 6 weeks
Medium water (15°-21°dH)	About every 2 months
Soft water (up to 7°dH)	About every 3 months
Or when the descaling indicator flashes.	

Descaling procedure		
Action	Comments	Descal LED indicator
	Fill water tank with commercial descaler according to the relevant instructions	
	Place an appropriately sized container under the HWS nozzle.	
Keep the descaling button pressed for about 5 sec.	Descaling programme is activated	ON
Open HWS valve	The pipes are rinsed with descaler at intervals. (Duration: approx. 45 min)	Light flashes
Programme end		LED of all 5 buttons flash
Close HWS valve	Descaling programme complete	Off
Rinse (fill tank 2x)	Open HWS valve	Off
Troubleshooting		
Fault	Remedy	
No display No power supply to machine.	Check mains fuses / Is machine plugged in? / Is main switch turned on?	
Water instead of coffee (powder button pressed)	- Place a measuring spoonful of coffee powder in the powder compartment	
Coffee is not hot enough	- Pre-heat cups	
	- Clean brewing unit if necessary	
	- Descale if necessary	
No hot water/steam Hot water/steam nozzle blocked	- Clean nozzle out with needle. (with machine turned off and closed rotary valve/HWS valve).	
Heating time too long, water quantity insufficient	- Descale machine	
The brewing unit cannot be removed.	- Close service door. - Turn machine on (brewing unit moves to home position)	
The brewing unit cannot be removed.	- Bring brewing unit to initial position.	
Cannot dispense		
Descaling indicator flashes	- Descale	
Espresso, coffee and steam buttons flash	- Overheating: Remove hot water until only espresso and coffee buttons are lit.	
Water LED lights up	- Fill with fresh water	
Water LED flashes	- De-aerate machine	
Coffee beans/Dregs LED lights up	- Fill with coffee beans	
Coffee beans/grinds container LED flashes	- Empty grinds container (machine must be turned on)	
Warning LED lights up	- Correctly install brewing unit, drip tray and grinds container.	
Warning LED flashes	- Grinder obstructed. - Gears obstructed - Contact an authorised service centre.	

2.3. User programme (Incanto Rapidsteam)

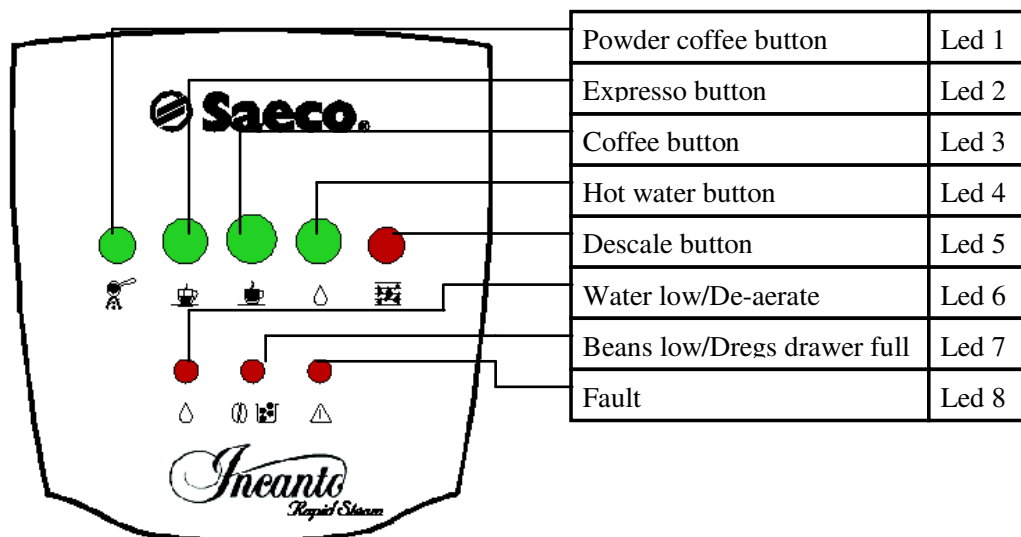

The table below indicates the various settings and programmes which can be selected through the user programme options.

Access: The machine must be turned on with the espresso and hot water buttons pressed in order to enter the programming mode.

Function	Button	Status	LED indicator
Water hardness setting for descaling indicator	Powder coffee (Press to activate an additional LED and then change descaling interval.)	0 – very soft water (0° - 3°dH) 1000 l	Led 1
		1 – soft water (4° - 7°dH) 500 l	Led 1+2
		2 – medium water (7°-14°dH) 300 l	Led 1+2+3
		3 – hard water (14°-21°dH) 150 l	Led 1+2+3+4
		4 – very hard water (over 21°dH) 80 l	Led 1+2+3+4+5
Rinse programme	Espresso	ON/OFF (LED lit up means programme activated)	Water Low LED
Pre-brewing	Coffee	ON/OFF (LED lit up means programme activated)	Coffee Beans Low LED
Pre-grinding	Hot water	ON/OFF (LED lit up means programme activated)	Fault LED

3. Operation (Incanto Digital/SBS)

3.1 Control panel

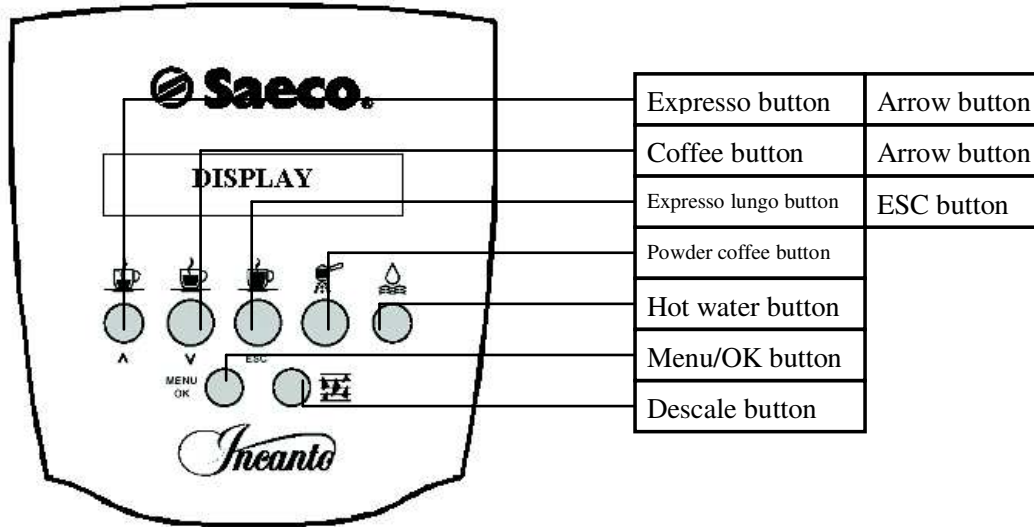

3.2. Operating instructions (quick reference)

	Action	Comments	Display
Getting started			
1	Unpack machine	Check for damage	
2	Fill water tank		
3	Fill coffee beans container		
4	Connect mains plug		
5	Turn on main switch		Self test/ Heating
6	De-aerate water circuit	Press hot water button. Open hot water pressure valve until water flows	Hot water Heating
		Heating stage (approx. 80 sec.)	Heating
		Ready	Select product Ready for operation
Making coffee			
7	Programme coffee quantity for each selection button. <ul style="list-style-type: none"> • Espresso lungo • Coffee • Espresso 	Depending on cup size. Programme by keeping the coffee selection button pressed until the desired quantity is reached.	Quantity programme
8	Set dispensing time, place cup under dispenser.	Only machines with SBS	Select product Ready for operation
9	Elect programme and press appropriate button	Press once = 1 cup of coffee Press twice = 2 cups of coffee	1 Coffee 2 Coffees
Coffee dispensing / Powder coffee			
10	Place cup under dispenser	Place powder coffee in powder container (1 measuring spoonful)	
11	Select powder button and relevant coffee button (espresso lungo / coffee / espresso)	Only one coffee can be dispensed at a time.	

Dispensing steam			
12	Open HWS valve	Immediately ready	Steam
Hot water dispensing			
13	Press hot water button.	Immediately ready	Hot water Ready for operation
14	Open HWS valve	Water removed	Hot water
15	Close HWS valve	Water removal complete	Hot water Ready for operation
16	Press hot water button.	Steam mode	Select product Ready for operation

Cleaning		
	Empty dregs drawer	Storage capacity of 13 tablespoons (Reset - empty only when indicated and with machine on)
	Empty drip tray	As required
	Clean water tank	As required
	Clean coffee bean container	As required
	Clean the housing	As required
	Rinse brewing unit	As required
	Clean brewing unit and lubricate	1 x per month
	Clean filter	
	Descaling	According to indicator

Descaling procedure			
Action	Comments	Indication	
Press descaling button	About 5 sec.	Descal (fill water tank)	
Fill water tank with commercial descaler according to the relevant instructions	Place an appropriately sized container under the HWS nozzle.	Descal	
Open HWS valve	The pipes are rinsed with descaler at intervals. (Duration: approx. 45 min)	Machine is descaled	
Programme end	When water tank is empty		
Close HWS valve	Descaling programme complete	Descaling complete	
Confirm with OK		Rinse Fill water tank	
Fill tank	Open HWS valve	Rinse machine.	
Programme end	When water tank is empty	Rinsing complete	
Close HWS valve	Rinse programme complete	Fill water tank	

The descaling indicator turns off automatically after completion of the descaling process!

Troubleshooting		
Fault/Indicator	Possible cause	Remedy
Machine does not function	No power	Check mains plug / mains circuit breaker Ensure machine door is closed
BREWING UNIT NOT DETECTED	Brewing unit not properly installed or not closed	Install brewing unit correctly
GRINDS CONTAINER NOT DETECTED	Coffee grinds container not properly installed	Brewing unit correctly installed
EMPTY GRINDS CONTAINER	Coffee grinds container full	Empty coffee grinds container (reset only possible if machine is turned on)
COFFEE BEAN CONTAINER EMPTY	Coffee bean container is empty	Fill coffee container
FILL WATER DE-AERATE	Water tank is empty	Water tank
GRINDER OBSTRUCTED		Clean grinder
DE-AERATE	Air in water system	Open water nozzle
Instead of coffee, only water is dispensed	Coffee powder selection button is pressed, but no coffee powder is dispensed	Add one level measure of coffee powder
No water / steam	Steam nozzle blocked	Free opening using a thin needle
The coffee flows too quickly	Beans ground too coarsely	Select lower grinding level; e.g. change from 8 to 6
The coffee flows too slowly	Beans ground too finely	Select higher grinding level; e.g. change from 8 to 10
Coffee is not hot enough	The cups are cold	Pre-heat cups
	Boiler temperature too low	Increase temperature in user programme
Coffee has no froth	Unsuitable coffee blend	Change brand of coffee
	Coffee is no longer freshly roasted	Use fresh coffee
	Beans ground too coarsely or finely	Change grinding level
Longer heating time or less hot water	The machine is calcified	Decalcify machine
The brewing unit cannot be removed	The brewing unit is not in home position	Turn machine on, close service door and check dregs drawer (the brewing unit goes automatically to home position)

3.3. User programme (Incanto Digital/SBS)

The table below indicates the various values, settings and programmes which can be read and selected through the user programme options.

Various cleaning programmes can also be activated.

Access: Access via Menu/OK button.

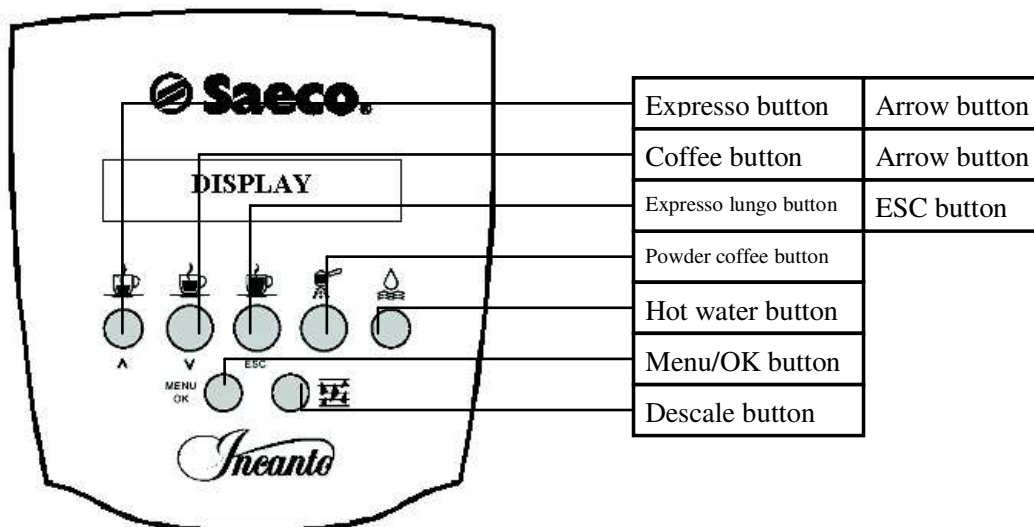

Menu procedure:

1. Select desired programme using the cursor buttons (arrow buttons).
2. Access appropriate item using the Menu/OK button.
3. Use the arrow buttons to handle each item.
4. Confirm with Menu/OK button.

Item	Setting/Indicator	Standard	Function
Standby			Temperature decrease.
Rinse	ON/OFF	OFF	Rinses residual water through pipes each time machine turned on (when machine is cold).
Language	Country	German	Display language
Water hardness	1 – 500 l	3	Change in water flow quantity until descaling required (1-4).
	2 – 300 l		
	3 – 150 l		
	4 – 80 l		
Heating plate	ON/OFF	ON	Activate / deactivate heating plate. Heating plate
Temperature	Maximum	Medium	Adjustment of coffee temperature.
	High		
	Medium		
	Low		
	Minimum		

Item	Setting/Indicator	Standard	Function
Pre-brewing	ON	ON	Coffee is moistened before actual brewing (better aroma)
	LONG		
	OFF		
Pre-grinding	ON/OFF	OFF	Pre-grinds the next coffee dose
Total coffee	Number		Coffee quantity indicator
Clock timer			Enter time Enter daily start-up time Enter daily shut-down time
Cleaning cycle			Cleaning programme for brewing unit
Factory settings			Initialise standard data

Exit: ESC button

4. Operation (Incanto Easy)

4.1. Control panel

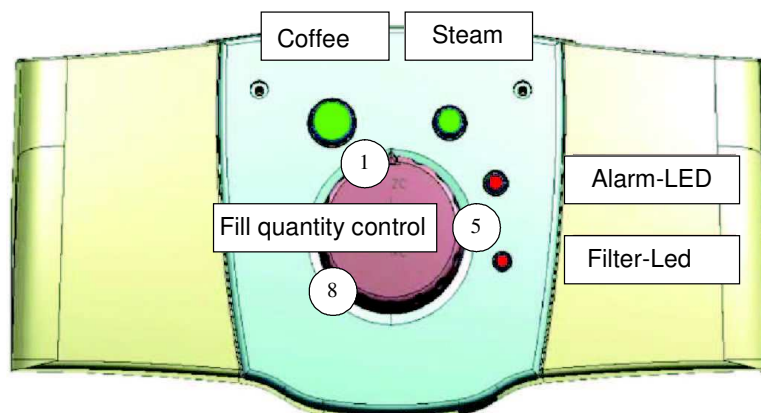

4.2. Operating instructions (quick reference)

	Action	Comments	Coffee LED	Steam LED
Getting started				
1	Unpack machine	Check for damage		
2	Install Aqua Prima filter			
3	Fill water tank	Wait for 30 min.		
4	Fill coffee beans container			
5	Connect mains plug			
6	Turn on main switch		Light flashes	
7	De-aerate water circuit	Open hot water pressure valve until water flows.	Light flashes	
		Heating stage (approx. 45 sec.)	Light flashes	
		Ready	ON	
Reset filter counter				
8	Press steam button	Filter LED flashes briefly		
Making coffee				
9	Pre-select cup fill volume with setting button.	Depending on cup size	ON	
10	Place cup under dispenser.			
11	Press start button (coffee button)	Coffee button	Light flashes	
Coffee dispensing / Powder coffee				
12	No powder dispensed			
Dispensing steam				
13	Press steam button	Heating stage		Light flashes
14		Ready		ON
15	Steam dispensing Open HWS valve	To heat beverages/to froth milk		ON
16	Press steam button / deactivate steam function.	Cool by de-aerating (until coffee button lights up)	Light flashes	Light flashes
		Ready (to make coffee)	ON	
Hot water dispensing				
17	Open HWS valve	Immediate	ON	

Cleaning		
Empty dregs drawer	Storage capacity 13 tabs.	
Empty drip tray	After 13 tabs.	
Clean water tank	As required	
Clean coffee bean container	As required	
Clean the housing	As required	
Rinse brewing unit	1 x per week	
Clean brewing unit and lubricate	1 x per month	
Clean filter		
Descale	Depending on water hardness.	
Descaling frequency		
Water hardness	Without Aqua Prima	With Aqua Prima
Very hard water (over 21°dH)	About 2 - 4 weeks	About 4 - 6 weeks
Hard water (15°-21°dH)	About 4 - 6 weeks	About every 2 months
Medium water (15°-21°dH)	About every 2 months	About every 3 months
Soft water (4-7°dH)	About every 3 months	About every 6 months
Soft water (0-3°dH)	About every 6 months	About every 6 months
Descaling procedure		
Action	Comments	
1 Remove Aqua Prima filter from water tank		
2 Fill water tank with descaler according to the relevant instructions (Saeco descaler recommended)	Place an appropriately sized container under the HWS nozzle	
3 Open HWS valve	Remove approx. 1/4 litre	
4 Turn machine off	Allow descaler to act for 10 min.	
5 Turn machine on and repeat Points 3 to 5 until the descaler mixture is used up		
6 Close HWS valve		
7 Fill tank with fresh water	Open HWS valve	
8 Rinse (until tank is empty)	Descaling complete	
9 Re-install Aqua Prima filter in water tank / Fill tank		
Troubleshooting		
Fault	Remedy	
No display No power supply to machine.	Check mains fuses / Is machine plugged in? / Is main switch turned on?	
Coffee is not hot enough	- Pre-heat cups - Clean brewing unit if necessary - Descale if necessary	
No hot water/steam Hot water/steam nozzle blocked	- Clean nozzle out with needle (with machine turned off and closed rotary valve/HWS valve)	
Heating time too long, water quantity insufficient	- Descale machine	
The brewing unit cannot be removed	- Close service door - Turn machine on (brewing unit moves to home position)	

Cannot dispense	
Espresso, coffee and steam buttons flash	- Overheating: Remove hot water until only espresso and coffee buttons are lit.
Filter warning LED lights up (MACHINE NOT LOCKED)	- Install Aqua Prima filter. Reset: Press steam button until filter warning LED flashes
Warning LED lights up	- Fill water tank. - Fill coffee beans container. - Empty grinds container
Warning LED flashes	- Dregs drawer/drip tray not installed. - Brewing unit not installed. - Doors not closed. - Grinder obstructed. - Gears obstructed - Contact an authorised service centre.

CHAPTER 4

FUNCTIONS AND TIMING

	Page
1. Water system	1
1.1. Water system (Incanto/Easy)	1
1.2. Water system (Incanto R. Steam/Dig.)	2
1.3. Water system (Incanto Dig. SBS)	3
2. Electrical system	4
2.1. CPU – IN / OUT (Incanto)	4
2.2. CPU – IN / OUT (Incanto Rapid Steam)	5
2.3. CPU – IN / OUT (Incanto Digital)	6
3. Timing	7
4. Function	8
4.1. Gearmotor	8
4.2. Gear resistor	8
4.3. Water level monitoring	8
4.4. Flow meter (Turbine)	9
4.5. HWD valve (steam operation)	9
4.6. Temperature sensor (KTY)	9
4.7. Grinder	10
4.8. Doser	10
4.9. SBS Saeco Brewing System	11
4.9.1 General functions	11
4.9.2 Frothing valve function	12
4.9.3. Extraction values with SBS	13

1. Water system

1.1. Water system (Incanto, Easy)

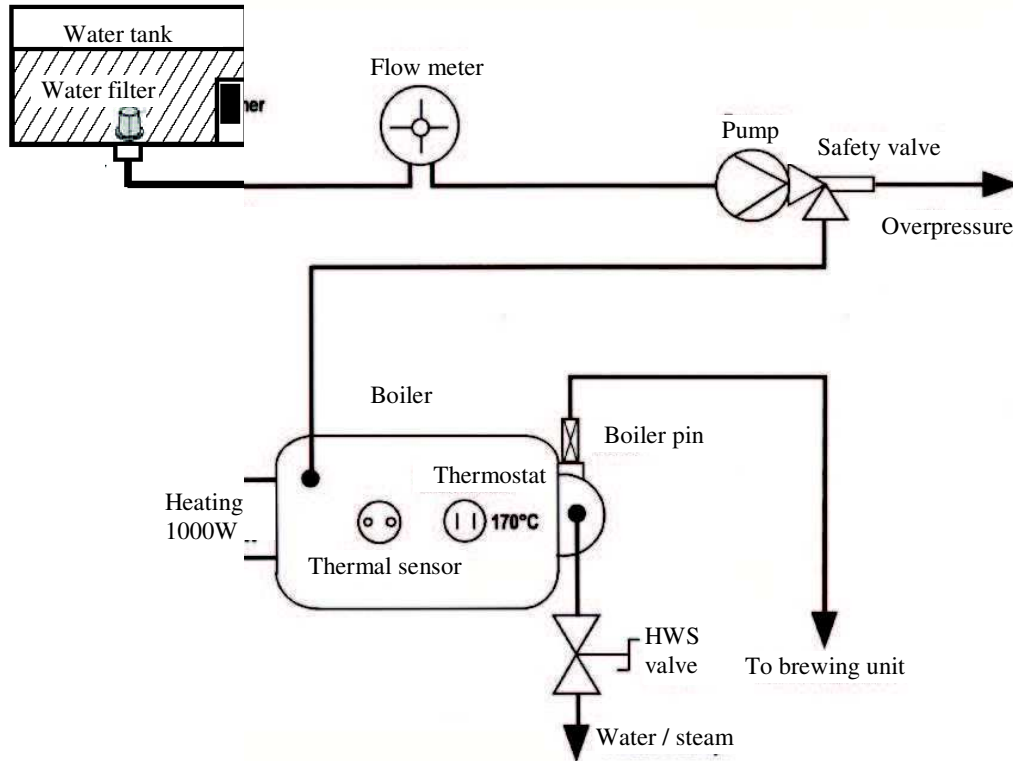

(Incanto Easy with boiler J)

	Component	Function
1	Water tank	Water supply
2	Float	Water level monitoring
3	Water filter	Water cleaned of solid matter
4	Flow meter (turbine)	Measure flow rate
5	Pump	Water flow/Pressure build-up (13 to 15 bar)
6	Safety valve	Protect boiler against overpressure (opens at 17 bar)
7	Instantaneous water heater	Heats water to approx. 94°C (for brewing process)
8	Sensor (KTY)	Transmits current temperature value to electronic system
9	Thermostat	Interrupts complete flow supply if overheating.
10	Boiler pin (Valve plug)	Opens when brewing unit is aligned with water circuit to the unit itself.
11	HWS valve	For hot water and steam dispensing

1. 2. Water system (Incanto Rapid Steam / Incanto Digital)

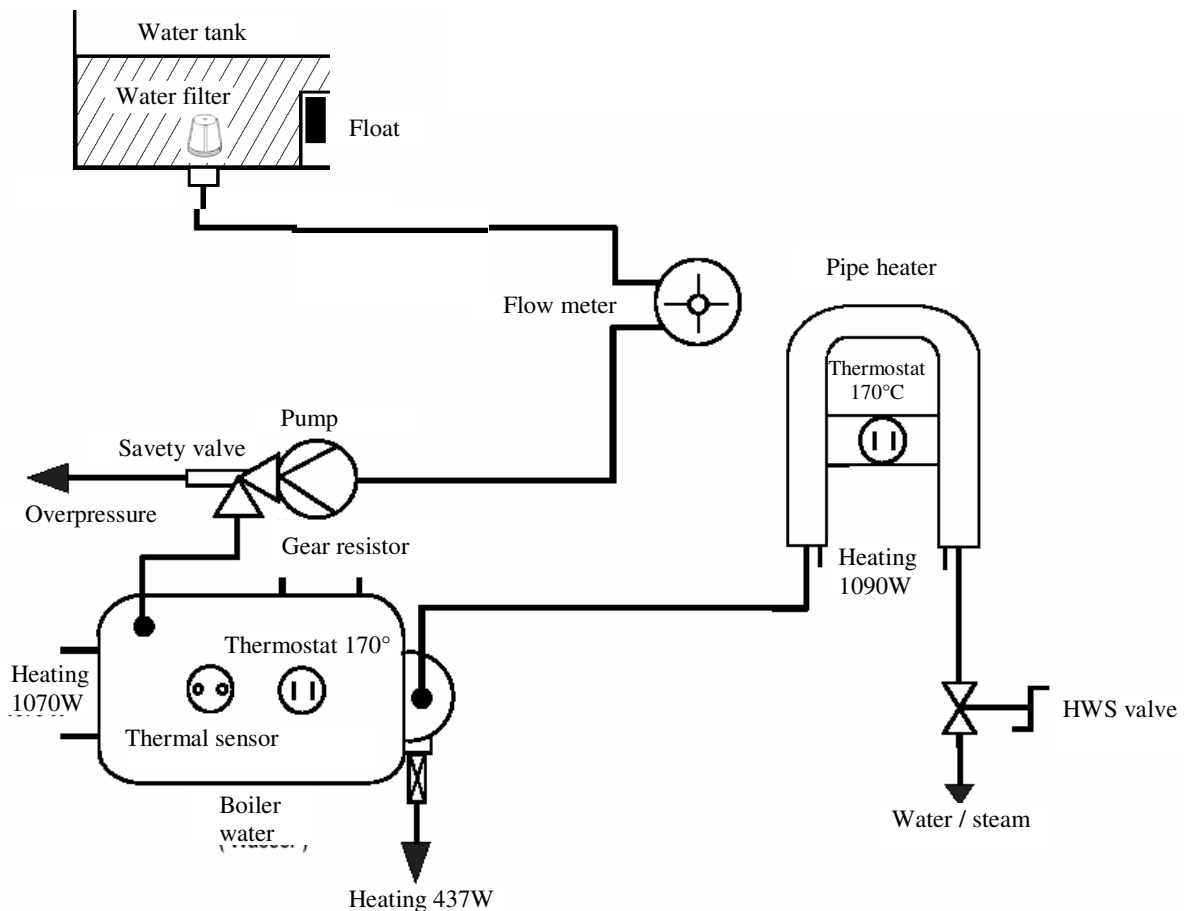

Component	Function
Water tank	Water supply
Water filter	Water cleaned of solid matter
Flow meter	Measure flow rate
Pump	Water flow/Pressure build-up (13 to 15 bar)
Safety valve	Protect boiler against overpressure (opens at 17 bar)
Boiler/Heating	Heats water to approx. 94°C (for brewing process)
Gear resistor	437 W
Sensor	Transmits current temperature value to electronic system
Thermostat	Turns off flow supply to entire machine if overheating
Valve plug	Opens when brewing unit is aligned with water circuit to the unit itself.
Pipe heating	Steams pre-heated boiler water for steam function
Thermostat (pipe heating)	Switches (pulses) pipe heating
HWS valve (tea nozzle)	For water and steam dispensing

1. 3. Water system (Incanto Digital SBS)

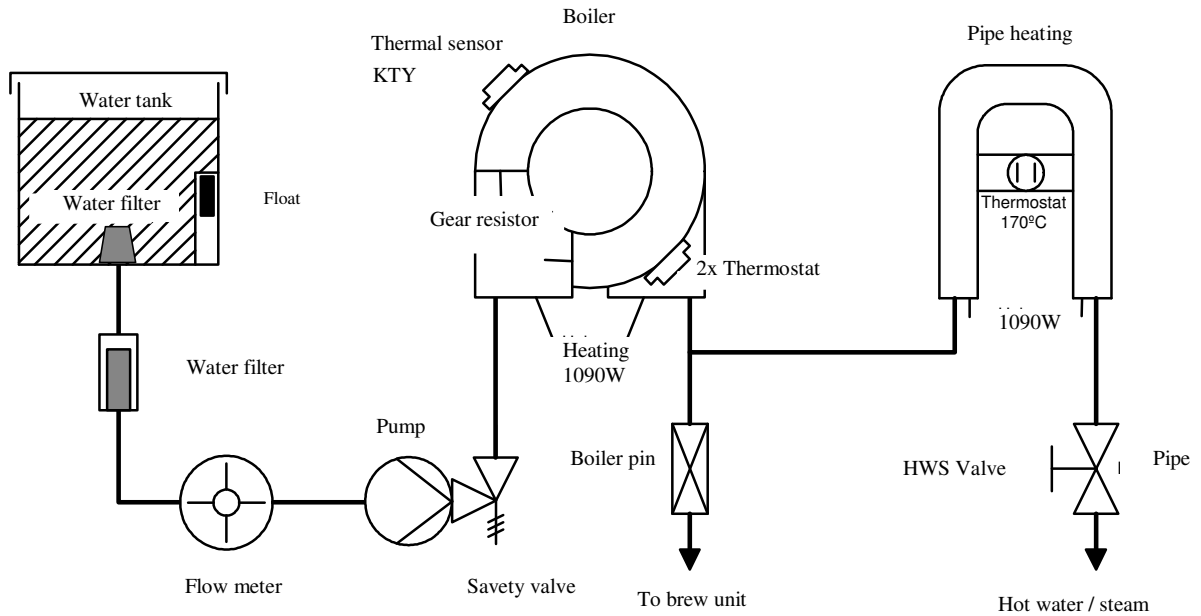

Component	Function
Water tank	Water supply
Water filter	Water cleaned of solid matter
Flow meter	Measure flow rate
Pump	Water flow/Pressure build-up (13 to 15 bar)
Safety valve	Protect boiler against overpressure (opens at 17 bar)
Boiler/Heating	Heats water to approx. 94°C (for brewing process)
Sensor	Transmits current temperature value to electronic system
Thermostat	Turns off flow supply to entire machine if overheating
Valve plug	Opens when brewing unit is aligned with water circuit to the unit itself
Pipe heating	Steams pre-heated boiler water for steam function
Thermostat (pipe heating)	Switches (pulses) pipe heating
HWS valve (tea nozzle)	For hot water and steam dispensing

2. Electrical system

2.1. CPU – IN / OUT (Incanto)

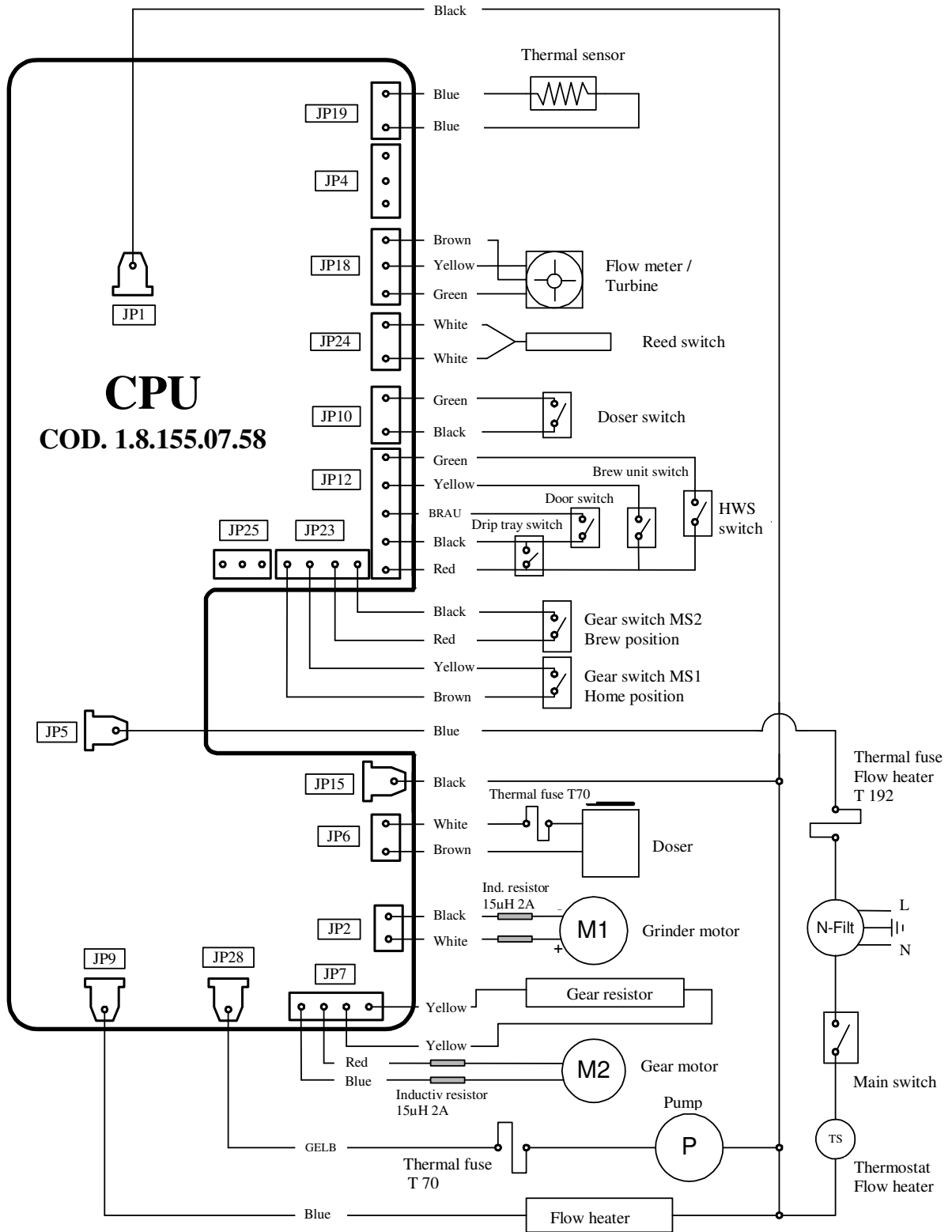

2.2. CPU - IN / OUT (Incanto Rapid Steam)

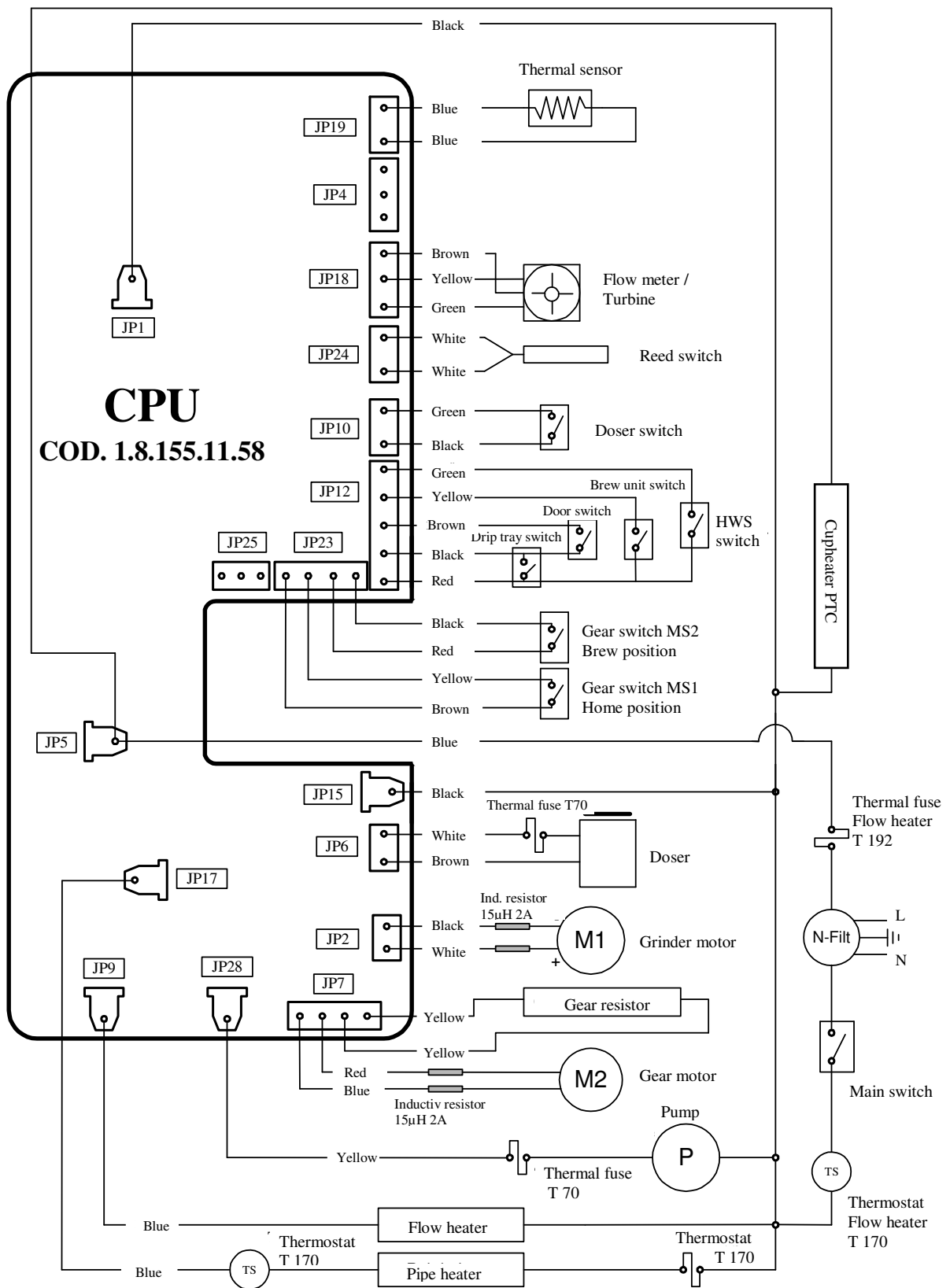

2.3. CPU - IN / OUT (Digital)

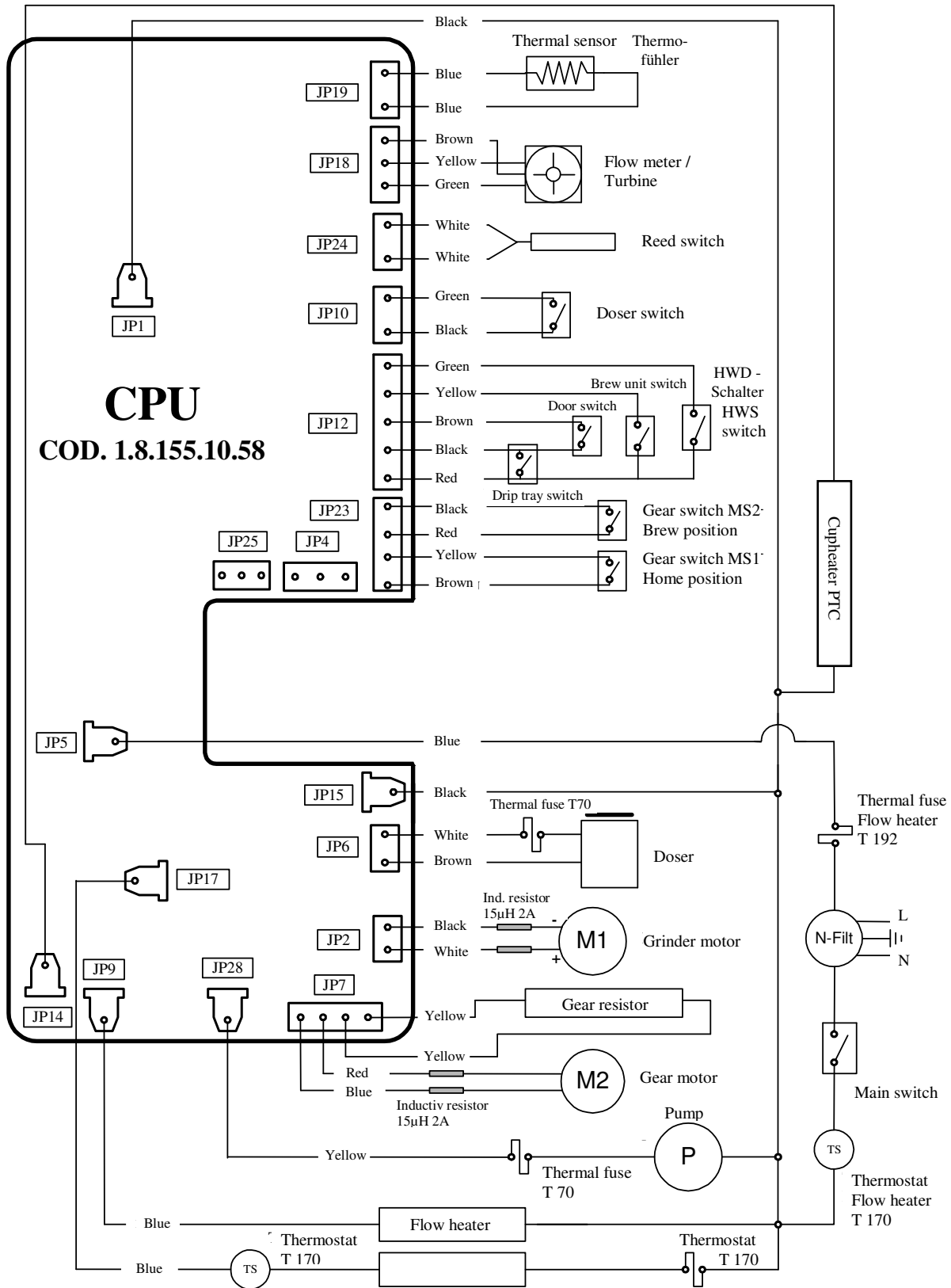

3. Timing

The following time chart indicates the functions of the individual components in terms to time

Grinder motor			app. 5.5 sec	
Doser				
Heating	app. 1.5 min			
Pump			*	Depending on coffee qty
Gear motor			Up	down
Status	Heating stage	Stand-by	Coffee process	

Note: * only in machines with pre-brewing system

Explanation:

Two processes start when the main switch is activated:

Firstly, the gearmotor is initialised: The gears move to MS1 (lower limit switch), change rotating direction, leave MS1 and move to the home position (about 2 mm after MS1).

The instantaneous water heater is then activated for about 1 min 30 sec., heating the water to operating temperature, whereby heating takes place for about 60 sec. continuously and then is alternated for the rest of the time.

After activating the start button:

1. The grinder starts operating (about 5.5 sec.).
2. The doser is activated three times.
3. The gears move to brewing position.
4. Pre-brewing begins (brief pump activation).
5. Main brewing process (duration of pump activation depending on selected coffee quantity).
6. The gears move to home position (dregs discarded).

4. Function

4.1. Gearmotor

The gearmotor is connected to the power element of the circuit board via the auxiliary heating system. In order to perform forward and backward movements, the gearmotor is controlled alternately with a positive and negative half wave. The voltage is limited by the electronic system to approx. 30 to 35 V. In the event of overload the motor's electronic system switches off after 8-10 sec. and the red fault LED flashes / brewing unit lock indicator.

If the brewing unit is locked in the upward movement, the cycle is interrupted after about 8 seconds and the control system attempts to move the brewing unit to the idle position. This occurs, for instance, when too much powder is present in the brewing chamber. If the brewing unit is locked in the downward movement, the motor turns off after 8 seconds and the machine is locked. This situation is indicated by the flashing fault LED / brewing unit lock indicator. The machine must be turned off and the cause of the lock removed.

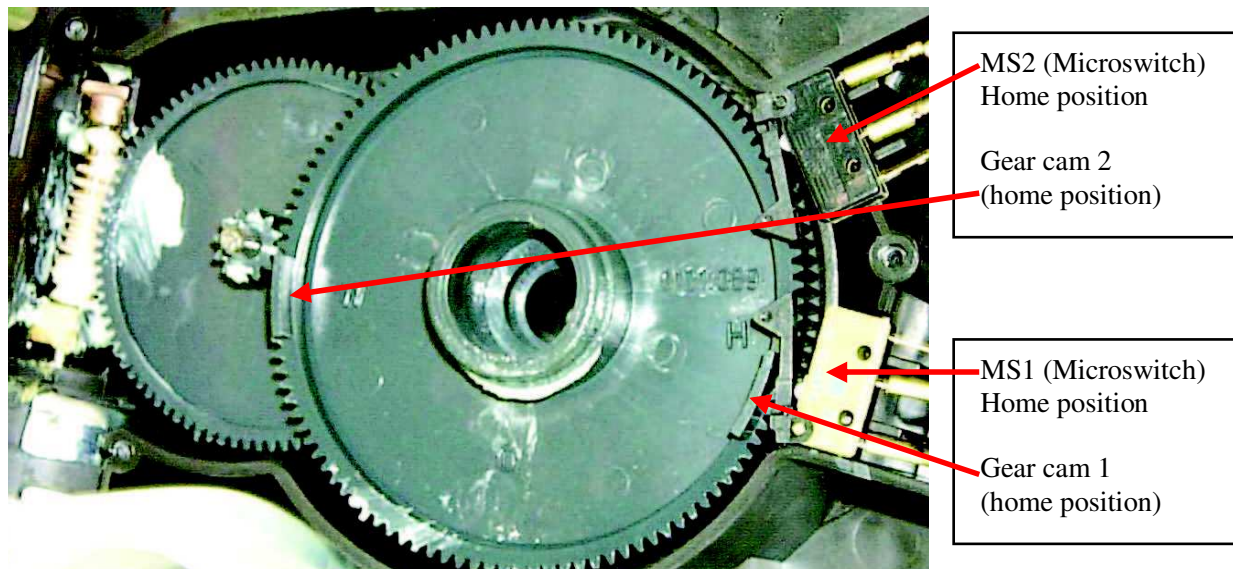

Note: The gear wheel must always be installed so that MS1 and MS2 are positioned at the long section of the switching cams!

4.2. Gear resistor

The heating system of the thermoblock with green marking at the connection point acts as resistor for the gearmotor. The gearmotor cannot function in the event of a defective heating system. The heating system (resistor) has a resistance of approx. 130 Ohm.

4.3. Water level indicator

The water level in the water tank is monitored by a float fitted with a magnet core. If the water level is too low, the magnet is no longer within the range of the reed contact, which transmits the low water level signal to the CPU (Water Low indicator).

4.4. Flow meter (Turbine)

The machine is equipped with a flow rate monitoring system. The system checks whether the turbine (flow meter) rotation speed at a particular time complies with the pre-set value. If no pulses are generated from the turbine within 10 seconds, the current cycle is interrupted. The Fault - De-aerate signal is indicated. If this control mechanism is activated, the machine must be de-aerated. During the Water Low signal, the pump operates at maximum output. As soon as the pump has generated the pre-set flow, the pump output is reduced to approx. 20 l/hr.

The water quantity is generally controlled according to the coffee quantity programmed through the flow meter (turbine) pulses.

4.5. HWS valve (steam operation)

The HWS valve is required for water and steam dispensing, as well as during de-aeration.

If the hot water valve is opened during the brewing process, coffee flow is interrupted and the De-aerate indicator will appear. As soon as the hot water valve is closed, the brewing process will continue.

The operating temperature during steam dispensing is approx. 125°C. The steam button is pressed to activate steam production (without rapid steam). Steam dispensing occurs via the HWS valve.

The pump pulses the steam dispensed. This means that constant steam dispensing is ensured over a long period of time. The flow rate of the pump is adjusted on the basis of the thermoblock temperature. If the temperature is too low, the pump pulses are slowed down. This may occur, for instance, when the hot water valve opens before the temperature indicator lights up.

Once the steam has been dispensed, the steam valve closes and the steam button must be pressed for normal operating mode. The overheating indicator flashes until the machine has cooled; the machine remains locked for coffee dispensing. Cooling can be achieved by opening the HWS valve. The pump functions at maximum output and the heating remains turned off as long as the Overheating signal remains. These measures ensure that the cooling process is accelerated and the De-aerate signal will disappear after a few seconds.

4.6. Temperature sensor (KTY 10)

The temperature sensor is a temperature-sensitive resistance mechanism, converting the boiler temperature into an electrical signal which is measurable by the CPU.

The CPU compares this signal with the programmed reference signal and, depending on the outcome of the comparison, controls the boiler output.

The resistance applied has a positive temperature coefficient; i.e. higher boiler temperature - higher sensor resistance.

The table below indicates the trend in resistance values in relation to the temperature.

Measured values (KTY)

Temperature	Resistance (Ω)	Resistance trend (Ω)
0	1629	0
15	1845	216
20	1922	77
40	2246	324
90	3168	922
100	3366	198
130	3979	613
140	4188	209

At room temperature the resistance is approx. 1.9K Ω .

4.7. Grinder

The grinder is a conical grinder with upper and lower grinding disc. The grinding level is set by adjusting the height of the upper grinding disc by means of the screw thread.

If the grinding discs are drawn apart by turning the grinding level adjusting ring (turning anti-clockwise), the grinding is coarser, while turning the adjusting ring clockwise will result in a finer grinding.

ATTENTION: Adjust the grinding level only when the grinder is in operation!

EXCEPTION: Grinder is empty.

The grinder operates with a direct current motor and the grinding disc rotation speed is determined by a gearmotor. The grinder motor operates with a voltage of 260 V direct current.

The grinder is equipped with an anti-gravel protection (friction clutch).

4.8. Doser

The coffee quantity for the current coffee process is portioned (dosed) in the doser chamber; a higher dose results in a stronger (more concentrated) coffee. A lower dose results in a weaker (less concentrated coffee).

The doser is controlled by a microswitch. The ground coffee is transferred from the grinder and is pressed into the dosing chamber; when the dosing chamber is full, the microswitch is activated and transmits to the CPU the signal to turn the grinding motor OFF.

Grinding is stopped, the dosing magnet engages, opens the dosing flap and the coffee falls into the brewing unit.

If the dosing microswitch is not activated within 20 seconds from start of the grinder motor, the coffee beans low signal appears.

The dosing quantity is set automatically by shifting the doser housing wall together with its microswitch.

Adjustments can be made with the hand wheel in the coffee bean container.

4.9. SBS Saeco Brewing System

4.9.1. General functioning

The water flow speed through the brewing unit can be slowed or accelerated by means of an adjustable flow valve (Fig. 2) which is activated by turning the knob on the front of the coffee machine.

The contact time of the water with the coffee in the brewing unit (extraction time), and consequently, the coffee concentration, is changed accordingly, while maintaining consistent froth formation.

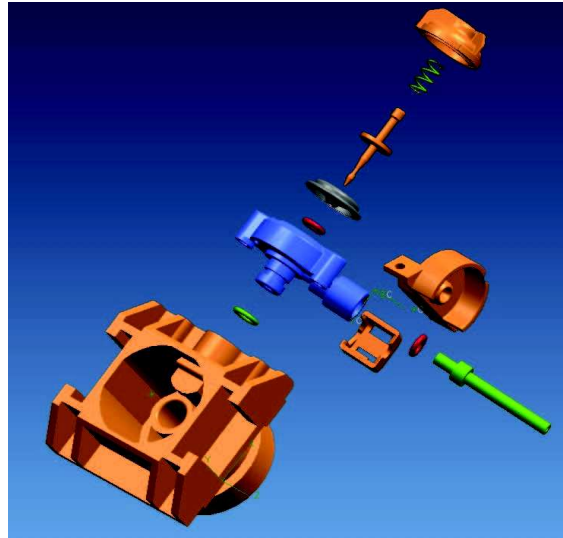

Fig. 1

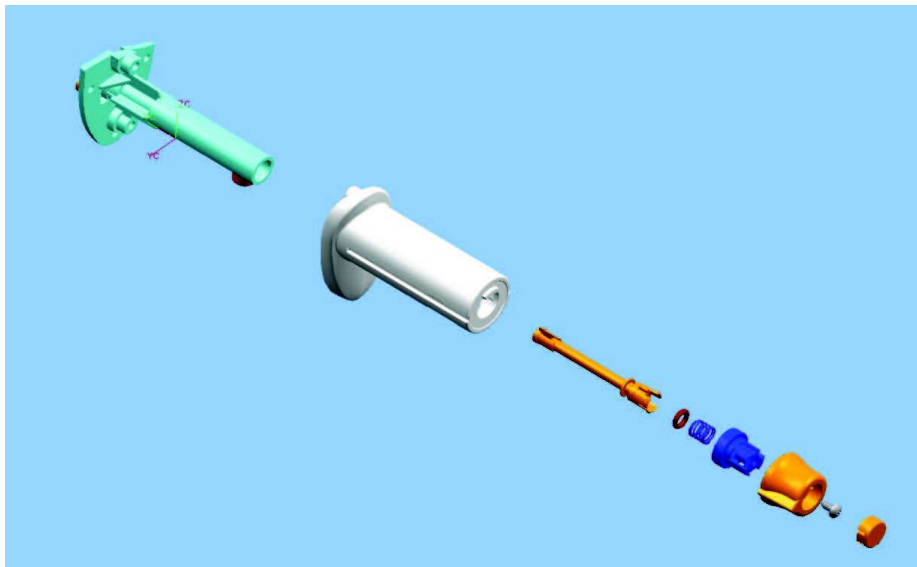

Fig. 2

4.9.2. Froth valve functioning

The backpressure in the froth valve and, consequently, on the membrane of the froth valve, is minimal when the flow valve is open. Accordingly, the valve needle is kept by the spring pressure in almost home position and the flow is at maximum (Fig. 3).

If the flow valve moves towards a minimum position, a backpressure results which creates an increased pressure on the membrane in the valve chamber. The membrane yields to the pressure and the valve needle further reduces the flow speed (Fig. 4).

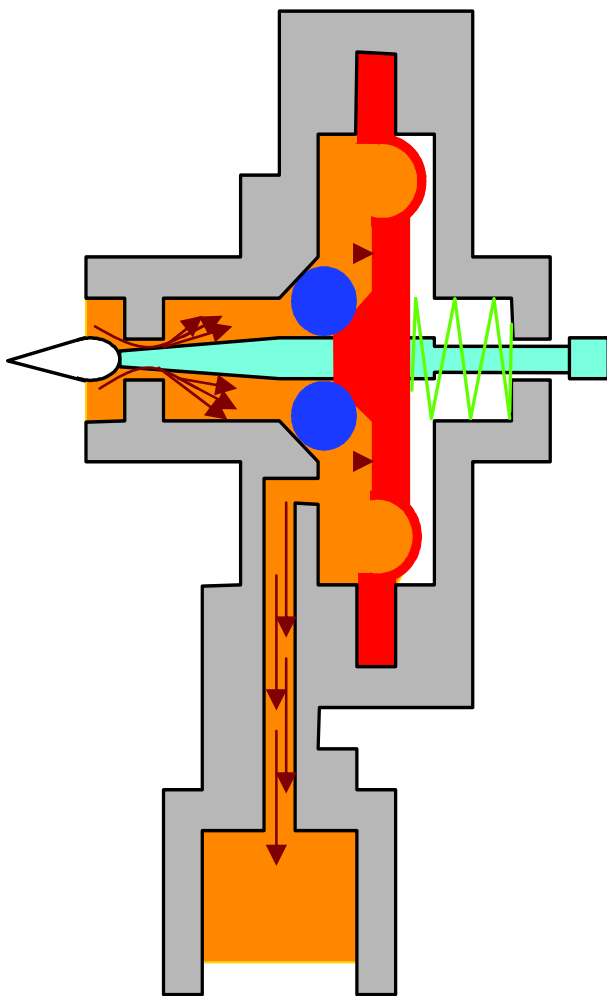

Fig. 3

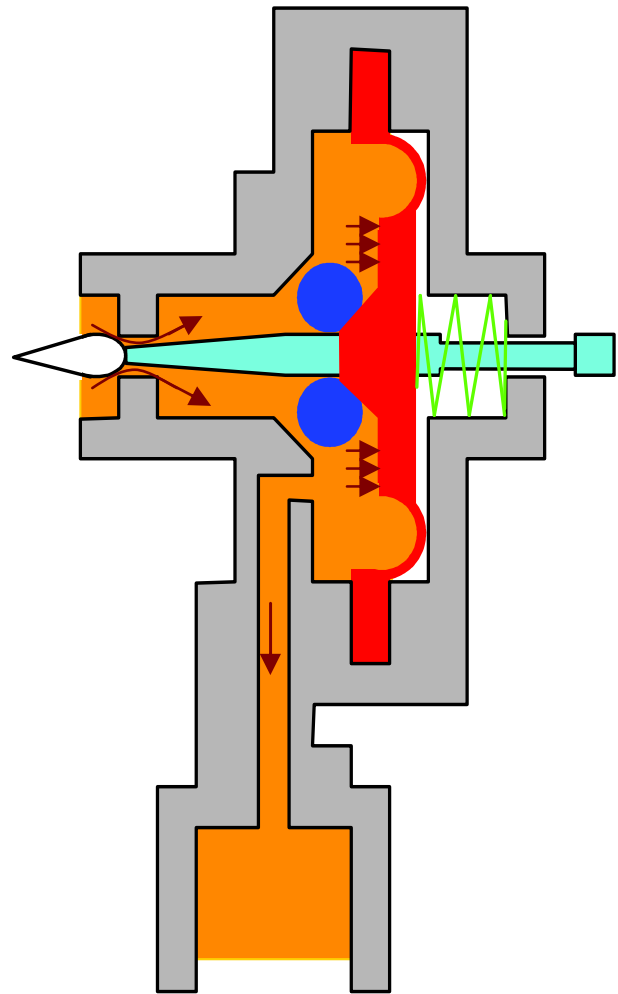

Fig. 4

4.9.3. Extraction values with SBS

A comparison of the measured values (dosing quantity 9g/SBS min.; dosing quantity 9g/SBS max. and dosing quantity 6g/SBS min.) indicates that the change from SBS min. to SBS max. corresponds with a change in dosing quantity of 1.5g.

Note: The pre-brewing function was deactivated during measuring.

CHAPTER 5

SERVICE PROGRAMME

	Page
1. Service programme (Incanto / Inc. R. Steam)	1
1.1. Functions programme	1
1.2. Diagnosis menu (diagnosis box)	3
2. Service programme (Incanto Digital)	6
2.1. Functions programme	6
2.2. Diagnosis menu	8
2. Service programme (Incanto Easy)	11
2.1. Functions programme	11

1. Service programme (Incanto Rapidsteam)

1.1.Functions programme

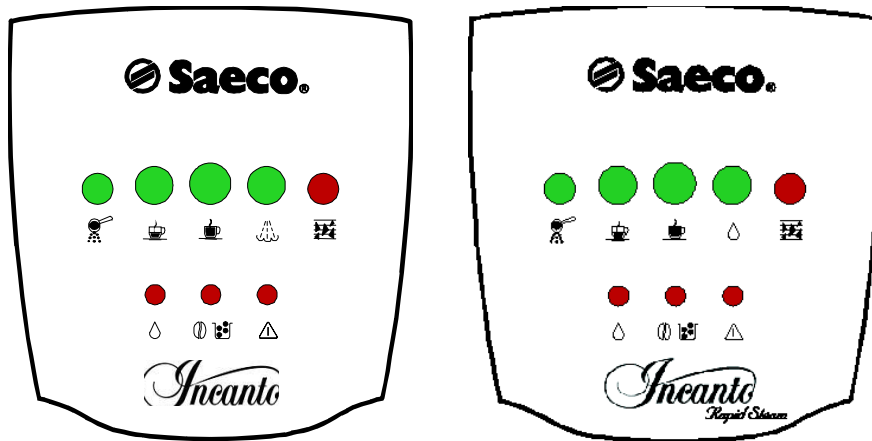

Access: Access the service mode by turning on the machine and simultaneously pressing the coffee and steam buttons.

The various functions indicated in the table can be checked by pressing the button combinations listed below.

Programme table (functions programme)

Buttons	Powder coffee	Espresso	Coffee	Steam/ Hot water	Descale	Microswitch status
Gears up	x					Powder LED (MS2)
Unit down		x				Espresso LED (MS1)
Grinder			x			Coffee LED (Doser switch)
Pump *	x	x				Fault LED (flow meter pulse)
Dosing magnet				x		
Heating system	x				x	
Heating + LED check	x				x + HWS	

* In order for the flow meter pulse to be indicated, the HWS valve must close once again after opening so that the HWS microswitch re-opens.

The following switches can also be tested in the same programme.

Microswitch	Control LED
Reed switch (Water low)	Water low
Dregs drawer/Drip tray	Coffee beans low
HWS switch	Fault LED
Door switch	Descaling LED
Brewing unit	Steam LED

1.2. Diagnosis menu (Incanto and Incanto Rapidsteam / Diagnosis box)**Application of diagnosis system**

The diagnosis system makes it possible to read data and enter settings into the Incanto and Incanto Rapid Steam coffee machines.

ATTENTION: Before connecting the diagnosis box, it is important to ensure that you have read the operating instructions.

Connection is via contact plug JP 25 of CPU.

Programme table (diagnosis menu)

Function/Standard	Setting range	Increment	Comments
EXPRESSO No. of PULSES 195	50 – 1,000 Pulses	+/- 1	Number of flow meter pulses for each saved cup fill volume, where 300 pulses correspond to approx. 100 ml.
COFFEE No. of PULSES 360	50 – 1,000 Pulses	+/- 1	
----HEATING---- PARAMETER K1 7	1 – 50	+/- 1	Do not change!
----HEATING---- PARAMETER K2 30	1 – 50	+/- 1	Do not change!
NORMAL TEMP. ° C 86	70- 130°C	+/- 1	Normal temperature is used if not more than 6 min. have elapsed since last coffee was dispensed.
HIGH TEMP. ° C 92	70- 130°C	+/- 1	If no coffee is dispensed for an extended time (over 6 min.), the next coffee will be heated to a higher temperature to compensate for cooling of the brewing unit and the associated temperature loss.
TEMP. OF 1st COFFEE ° C 94	70- 130°C	+/- 1	Used when dispensing the first coffee after the machine has been turned on, to compensate for the high temperature loss due to the cold brewing unit and water pipes.
STEAM TEMP. ° C 125	70- 135°C	+/-1	Boiler temperature for steam function (only in machines without pipe heating).

Function	Setting range	Increment	Comments
TEMP. INCREASE ° C 10	0-50°C	+/-1	The boiler temperature is increased by a set value shortly before brewing in order to pre-heat the boiler and compensate for the temperature drop during the first water flow.
PRE-BREWING 1	0 – 1		0 – Deactivate pre-brewing 1 – Activate pre-brewing
GRINDS COUNTER Number	0-50	+/-1	Counts number of coffee cycles. When this value reaches the Grinds Stop value, "GRINDS CONTAINER EMPTY" will be displayed. (Reset by removing dregs drawer for emptying within a min. of 6 sec.)
GRINDS MAXIMUM 13	5-50	+/-1	Number of cycles until "EMPTY GRINDS CONTAINER" is displayed.
--TOTAL COFFEE-- CYCLES Number	-----	-----	Total of all coffee cycles, cannot be reset.
--TOTAL WATER-- (ml) Number	-----	-----	Total water flow volume (in ml) / not resettable
WATER DESCALING (ml)	-----	-----	Total water flow (in ml) since last descaling / resettable.
HOT WATER FLOW (l/h) 20	6 - 34 l/h	+/- 2 l/h	The pump delivery rate for hot water can be expressed in litres per hour.
--HOT WATER--- PUMP ADJUST. 63000	58,000 - 65,500	+/- 1	The pump delivery rate is adjusted in relation to the HOT WATER FLOW setting by means of a phase controlled modulator. Pump tolerances can thus also be adjusted. An equivalent value is saved under HOT WATER PUMP ADJUSTMENT.
WATER HARDNESS 3	1 – 4		Value set in user menu for descaling interval
MACHINE STATUS 128	0 – 255		Programme code

Function	Setting range	Increment	Comments
--DATE OF MANUF--- DAY	-----	-----	This date indicates when the machine was manufactured. This date cannot be changed, but can be printed.
--DATE OF MANUF--- MONTH	-----	-----	
--DATE OF MANUF--- YEAR	-----	-----	
--SERVICE DATE-- DAY	0 - 31	+/- 1	The service date indicates the date of the machine's last service. This date can be changed and must be updated at each service.
--SERVICE DATE-- MONTH	0 - 12	+/- 1	
--SERVICE DATE-- YEAR	1996 - 2050	+/- 1	

2. Service programme (Incanto Digital)

2.1. Functions programme

Access: Access the service programme from the standby mode (press 2x Menu/OK) by keeping the EXPRESSO LUNGO and HOT WATER button pressed, whilst pressing the MENU/OK button again.

While the buttons are kept pressed, the current software version is shown.

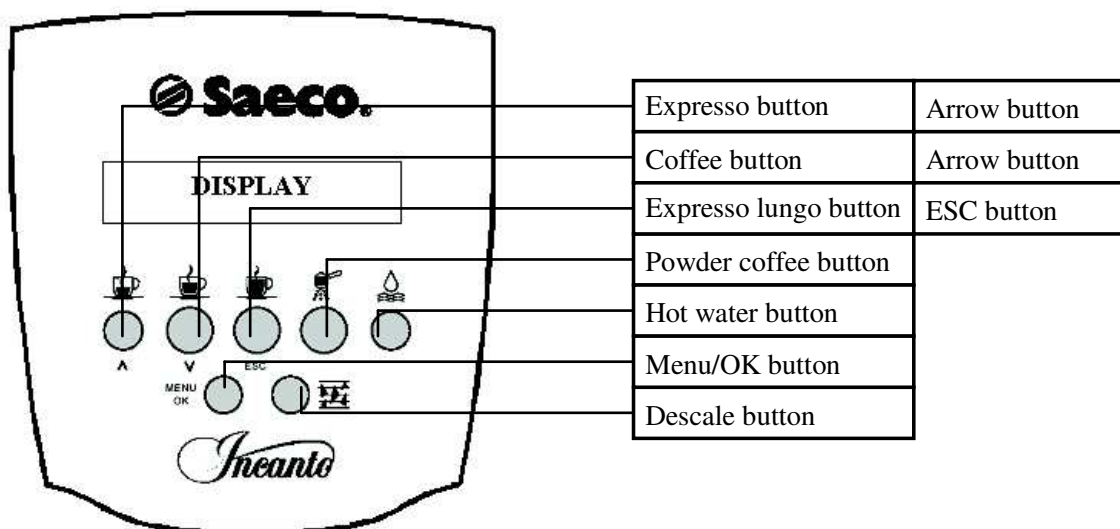

The various functions indicated in the table can be checked by pressing the button combinations listed below.

Programme table (functions programme)

Buttons	S1 Espresso	S2 Coffee	S3 Espresso lungo	S4 Powder coffee	S5 Hot water	S6 Menu/OK	S7 Descal
Unit up	x						
Unit down		x					
Grinder			x				
Pump	x						x
Doser				x			
Heating plate	x				x		
Heating system Instantaneous water heater		x				x	
Pipe heating			x			x	
Temperature indicator in °C				x		x	x

The upper display line signals the activated microswitch and the Hall effect of the turbine.
The activated buttons are signalled by the lower display line (e.g. 1=S1, 2=S2, etc.).

All CPU input signals from the machine appear in the first line of the display.
1 = Brewing unit in brewing position (brewing position microswitch activated)
2 = Brewing unit in at-rest position (idle position microswitch activated)
3 = Doser microswitch activated (full)
4 = HWS valve microswitch activated
5 = Grinds container microswitch activated
6 = Brewing unit microswitch activated
7 = Water tank full (reed contact not activated)
8 = Flow meter pulse
9 = Front door microswitch
All CPU input signals from the control board appear in the second line of the display.
1 = Espresso
2 = Coffee
3 = Espresso lungo
4 = Powder coffee
5 = Hot water pre-selection
6 = Stand-by button

Flow rate:

If the pump is activated during test mode and the hot water valve opened, a two-digit number appears at the bottom right side indicating the flow rate. This value must be between 40 - 60.

Grinder rate:

If no button is activated, a number appears at the bottom right side referring to the grinder rate. This value must be between 125 - 135.

Exit: Switch the machine off at the main switch.

2.2. Diagnosis menu (Incanto Digital)

The values below can be read and adjusted in the diagnosis menu as shown in the table.

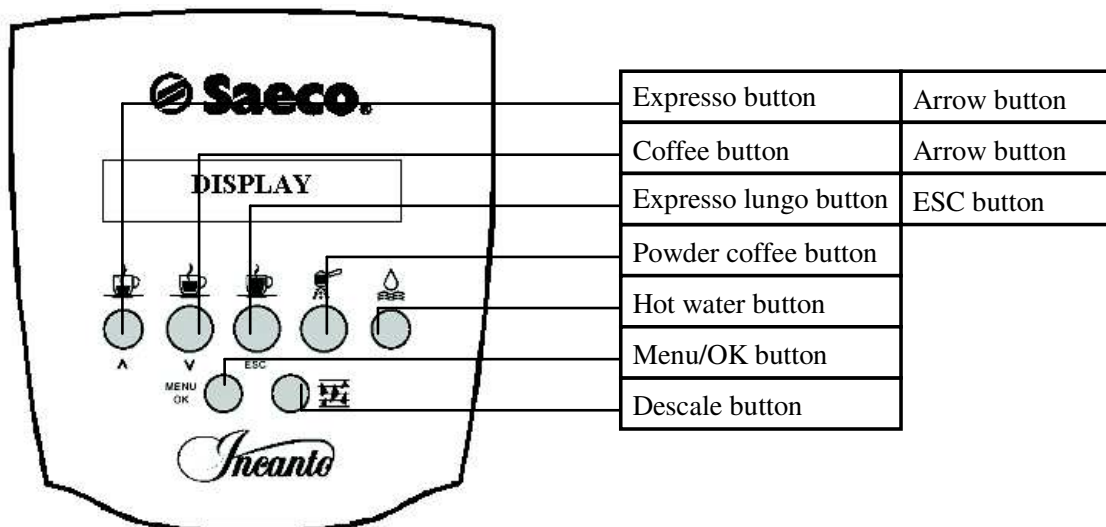

Access: Access from the standby mode (press 2x Menu/OK) by keeping the EXPRESSO, EXPRESSO LUNGO and HOT WATER button pressed and pressing the MENU/OK button with a slight delay. (The user programme is also available in this mode.)

Using the ▲ button scroll to the menu item "Diagnosis" and confirm using Menu/OK.

Changing programme values: Access appropriate item using the Menu/OK button.
Change value with ARROW buttons
Save value by using Menu/OK.

Programme table (diagnosis menu):

Function/Standard	Setting range	Increment	Comments
EXPRESSO LUNGO No. of PULSES 600	50 - 1,000 Pulses	+/- 1	Number of flow meter pulses for each saved cup fill volume, where 300 pulses correspond to approx. 100 ml.
EXPRESSO No. of PULSES 200	50 - 1,000 Pulses	+/- 1	
COFFEE No. of PULSES 360	50 - 1,000 Pulses	+/- 1	
----HEATING---- PARAMETER K1 7	1 - 50	+/- 1	Do not change!
----HEATING---- PARAMETER K2 30	1 - 50	+/- 1	Do not change!

Function/Standard	Setting range	Increment	Comments
----HEATING---- SENSOR ADJUST. 96			To adjust processor tolerances. If the temperature in test mode with a set measuring resistance of 3246Ω exceeds or falls short of the specified temperature value (96°C) by more than 1°C, the value indicated in test mode must be applied to adjust the sensor. No measuring resistance: Do not change!
NORMAL TEMP. ° C 84	70- 130°C	+/- 1	Normal temperature is used if not more than 6 min. have elapsed since last coffee dispensed.
HIGH TEMP. ° C 90	70- 130°C	+/- 1	If no coffee is dispensed for an extended time (over 6 min.), the next coffee will be heated to a higher temperature to compensate for cooling of the brewing unit and the associated temperature loss.
TEMP. OF 1st COFFEE ° C 92	70- 130°C	+/- 1	Used when dispensing the first coffee after the machine has been turned on, to compensate for the high temperature loss due to the cold brewing unit and water pipes.
STEAM TEMP. ° C 125	70- 135°C	+/-1	No function
TEMP. INCREASE ° C 10	0-50°C	+/-1	The boiler temperature is increased by a set value shortly before brewing in order to pre-heat the boiler. and compensate for the temperature drop during the first water flow.
GRINDS COUNTER Number	0-50	+/-1	Counts number of coffee cycles. When this value reaches the Grinds Stop value, "GRINDS CONTAINER EMPTY" will be displayed. (Reset by removing dregs drawer for emptying - min. 6 sec.)
GRINDS STOP 13	5-50	+/-1	Number of cycles until "EMPTY GRINDS CONTAINER" is displayed.
TOTAL WATER (ml) Number			Total water flow volume (in ml) / not resettable

Function/Standard	Setting range	Increment	Comments
WATER DESCALING (ml)			Total water flow (in ml) since last descaling / resettable.
HOT WATER FLOW (l/h) 20	6 - 34 l/h	+/- 2 l/h	The pump delivery rate for hot water can be expressed in litres per hour.
HOT WATER PUMP ADJUST. 63000	58,000 - 65,500	+/- 1	The pump delivery rate is adjusted in relation to the HOT WATER FLOW setting by means of a phase controlled modulator. Pump tolerances can thus also be adjusted. An equivalent value is saved under HOT WATER PUMP ADJUSTMENT.
WATER RESERVE COUNTER NUMBER			When the water tank is full, the value from WATER RESERVE STOP is applied. The flow meter pulses are counted from when the reed switch is switched and deducted from the value. If a beverage is chosen for which the saved pulse number is higher than the remaining pulses, the message FILL WATER TANK appears.
WATER RESERVE STOP 600			Water reserve from when the read switch is switched to pulses.
MACHINE STATUS 36	0 - 255		Programme code
--DATE OF MANUF-- DAY	-----	----- --	This date indicates when the machine was manufactured. This date cannot be changed.
--DATE OF MANUF-- MONTH	-----	----- --	
--DATE OF MANUF-- YEAR	-----	----- --	
--SERVICE DATE-- DAY	0 - 31	+/- 1	The service date indicates the date of the machine's last service. This date can be changed and must be updated at each service.
--SERVICE DATE-- MONTH	0 - 12	+/- 1	
--SERVICE DATE-- YEAR	1996 - 2050	+/- 1	

Exit: Switch the machine off at the main switch.

3.Service programme (Easy)

3.1.Test mode

Access: Access the service mode by turning on the machine and simultaneously pressing the double espresso and steam buttons.
Press Coffee and Steam buttons.

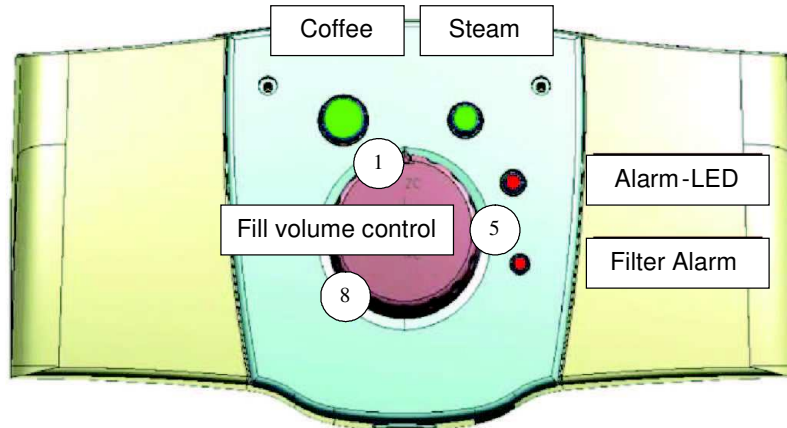

Various test functions can be activated in the service mode by activating either the coffee or steam buttons in conjunction with various coffee quantity settings.

Programme table

Function	Button	Control setting Cup fill volume	Indicator LED
Pump/Flow meter	Coffee +HWS		Fault LED (flow meter pulses) *
Brewing unit (Gearmotor) Brewing pos. ↑	Steam		Coffee LED Gear switch
Heating system	Coffee		
Brewing unit (Gearmotor) Home pos. ↓	Steam(Hot water)		Coffee LED (Gear switch)
Dosing magnet	Coffee		
Grinder	Steam (Hot water)		Steam LED Doser full
Microswitch HWS			Steam LED
Microswitch Door			Fault LED flashes
Microswitch Brewing unit			Fault LED flashes
Microswitch Grinds container			Fault LED flashes

CHAPTER 6

FAULTS

	Page
1. Faults	1

1. Faults:

The following table indicates the most common faults, listed by component.

Part	Fault	Cause
Heating	Does not function (no indicator light)	HS LED defective
		Electronic system defective
	Cold coffee Standby LED lights up continuously	KTY defective
		Electronic system defective
	Temperature differences No froth	KTY defective
		Electronic system defective
	Heating remains cold Coffee and espresso LEDs flash continuously	Heating - Interruption
Thermal fuse defective		
Heating plug connection		
Does not function	Interruption	
Doser	Water instead of coffee	Doser switch constantly activated / Dirt
		Defective doser rinse
	Weak coffee	Dose quantity too low
		Coffee residue in dosing chamber (under-dose)
Fault LED (coffee beans low) lights up constantly - Brewing unit overfull - Gearmotor obstructed	Doser switch does not work	
	Electronic system defective	
Grinder	Coffee too strong / flows too slowly	Grinding set too finely
	Coffee too weak / flows too fast, no froth	Grind set too coarsely
		Grinder motor not properly installed
	Grinder functions until fault LED (coffee beans low) lights up (insufficient beans in bean container)	Grinding disc worn
		Water in grinder
	Grinder does not work	Motor defective
Electronic system defective		
Sensor defective		
Gear defective		

Part	Fault	Cause
Gearmotor	Brewing unit malfunctions - does not move to home position	MS defective
		Motor defective
		Motor resistor defective
		Loose motor connections
		Gear wheel defective
		Electronic system defective
Brewing unit	Sluggish / obstructed	Plunger stiff
		Gasket of valve plug swollen (black O-ring)
		Gasket of plunger swollen
HWS system	HWS valve does not open (no water or steam dispensing possible)	Securing tab on tea nozzle spout broken / bent
	Water drips from steam pipe (with closed valve)	Valve gasket calcified
	Water drips from steam pipe shaft	Fracture in steam pipe
	Water leakage from HWS spout	Defective O-ring
	Water leakage at joint	Defective O-ring
Overpressure valve	Varying cup filling volume	Overpressure valve does not seal / calcified
	More water in drip tray	
Pump	Dry coffee in dregs drawer / water low indicator (fault LED)	Defective pump
	Water leakage at overpressure valve threaded joint	Thermal fuse defective
		Hairline crack in joint area

Part	Fault	Cause
Turbine	Varying coffee quantity Indicator signals need for de-aerating with water tank sufficiently full.	Turbine calcified / other deposits
		Hall sensor defective
		Connections oxidised
Float	Water low indicator lights up (although water tank is not empty)	Float not watertight
		Float jammed
		Magnet in float too weak
		Electronic system defective

ATTENTION: A defective temperature sensor (KTY) may be responsible for an unexplained functioning mode.

CHAPTER 7

FAULT DIAGNOSIS

	Page
1. Fault detection (Incanto)	1
1.1. Machine does not function	1
1.2. Water Low indicator	2
1.3. De-aerate indicator	3
1.4. Coffee Beans Low indicator	4
1.5. Grinds Container Absent indicator	5
1.6. Machine does not function (fault LED flashes)	6
1.7. Brewing unit / Gearmotor obstructed	7

1. Fault detection (Incanto)

1.1. Machine does not function

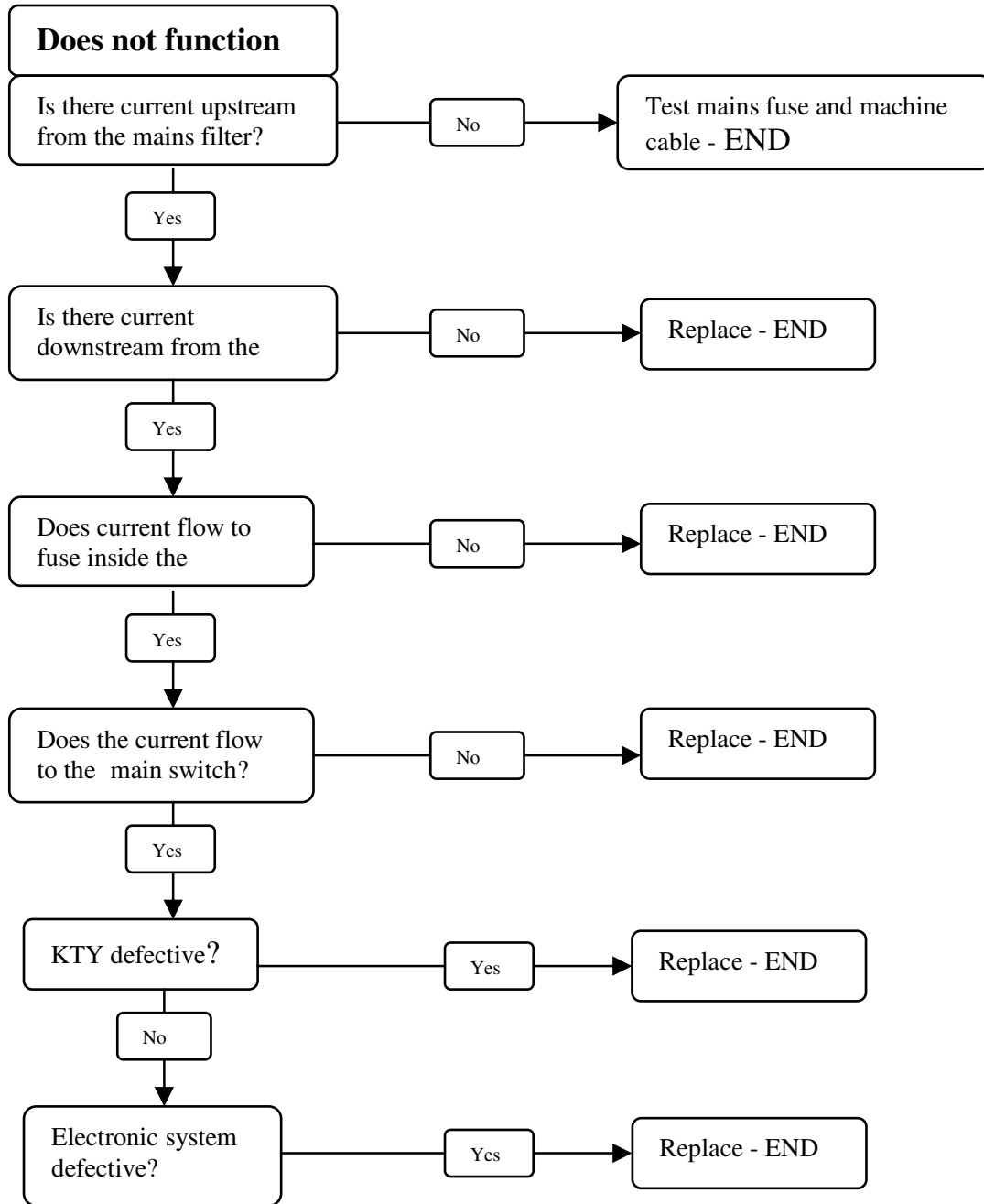

1.2. Water low

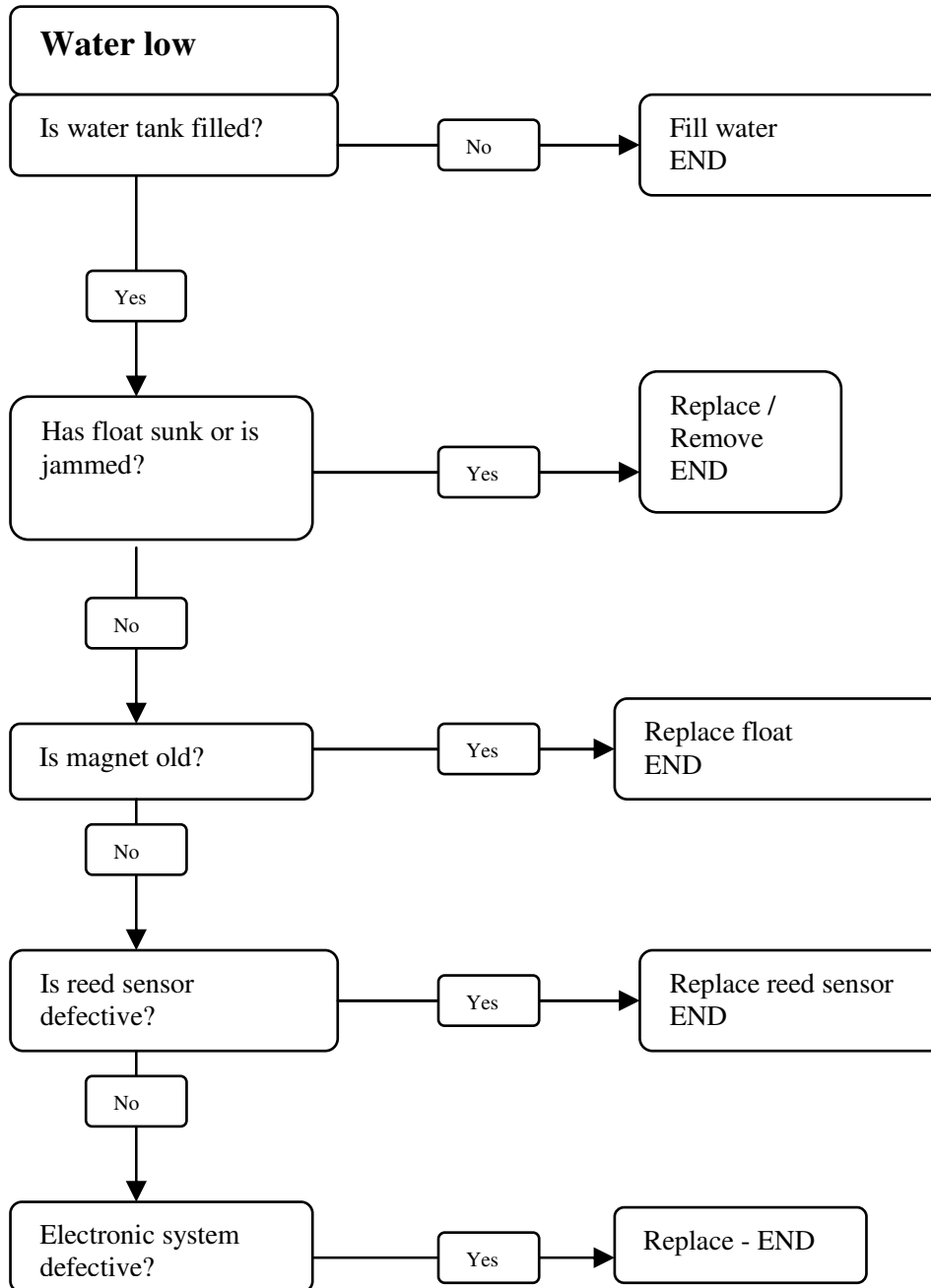

1.3. De-aerate indicator

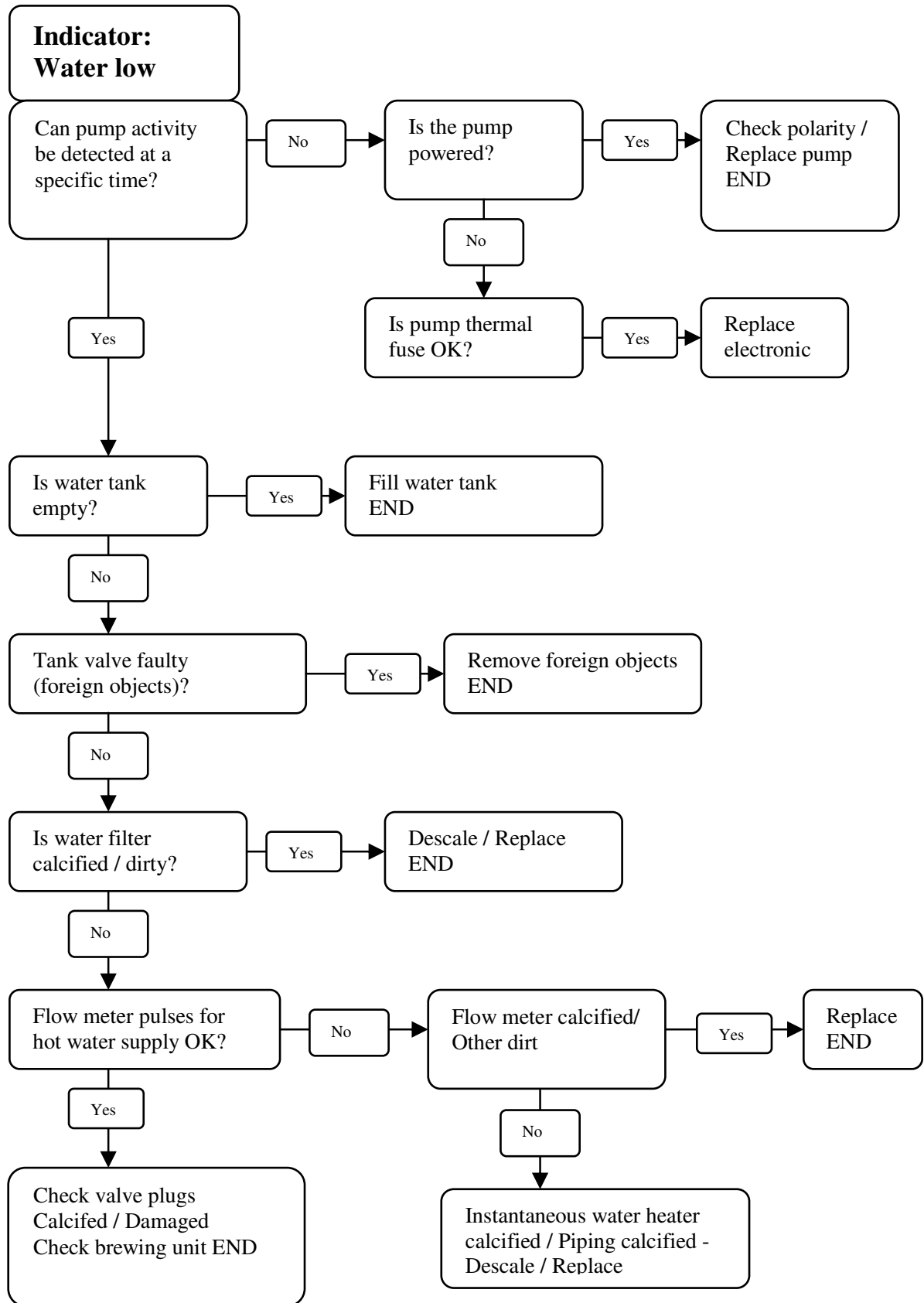

1.4 Coffee Beans Low indicator

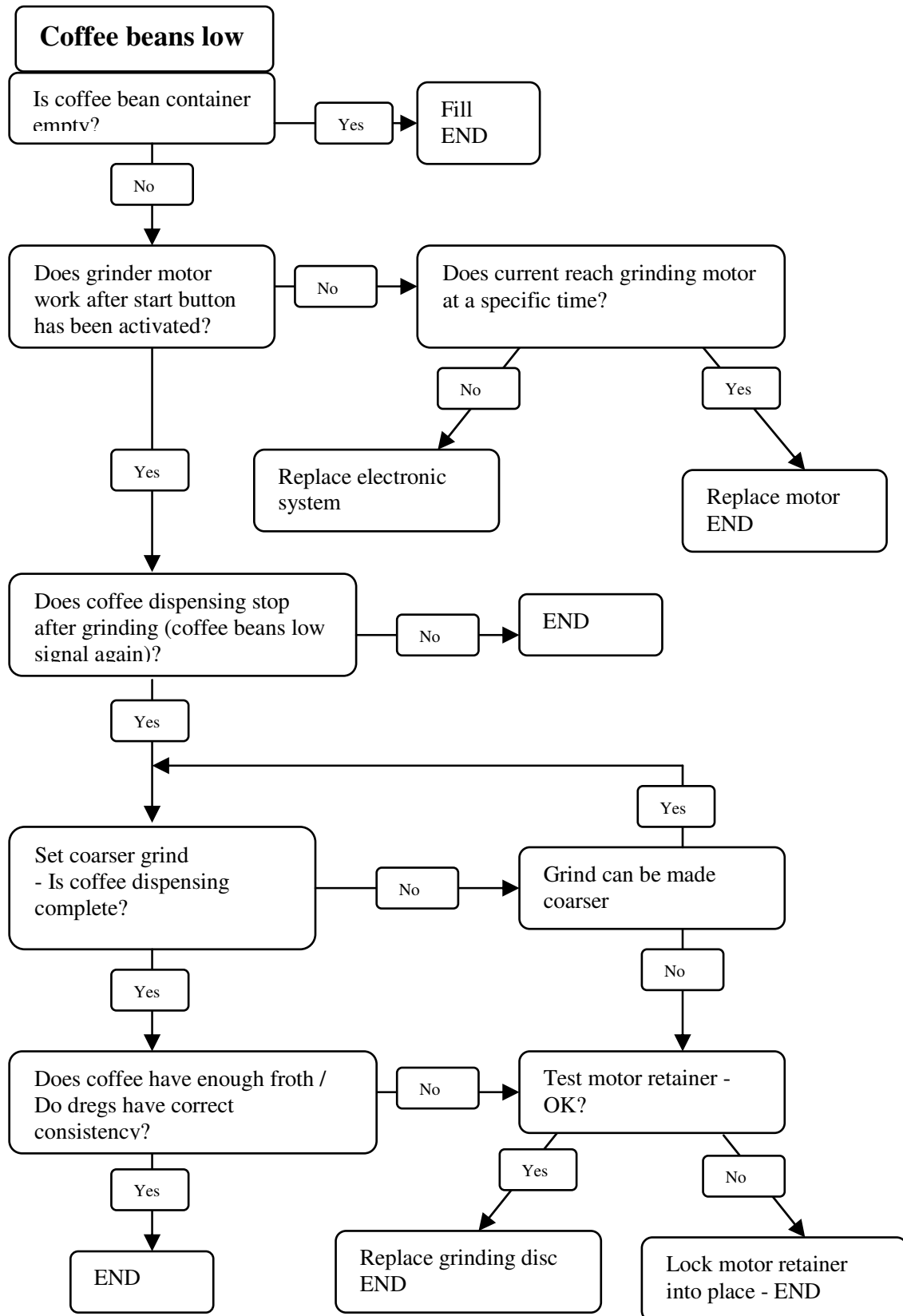

1.5. Grinds Container Absent indicator

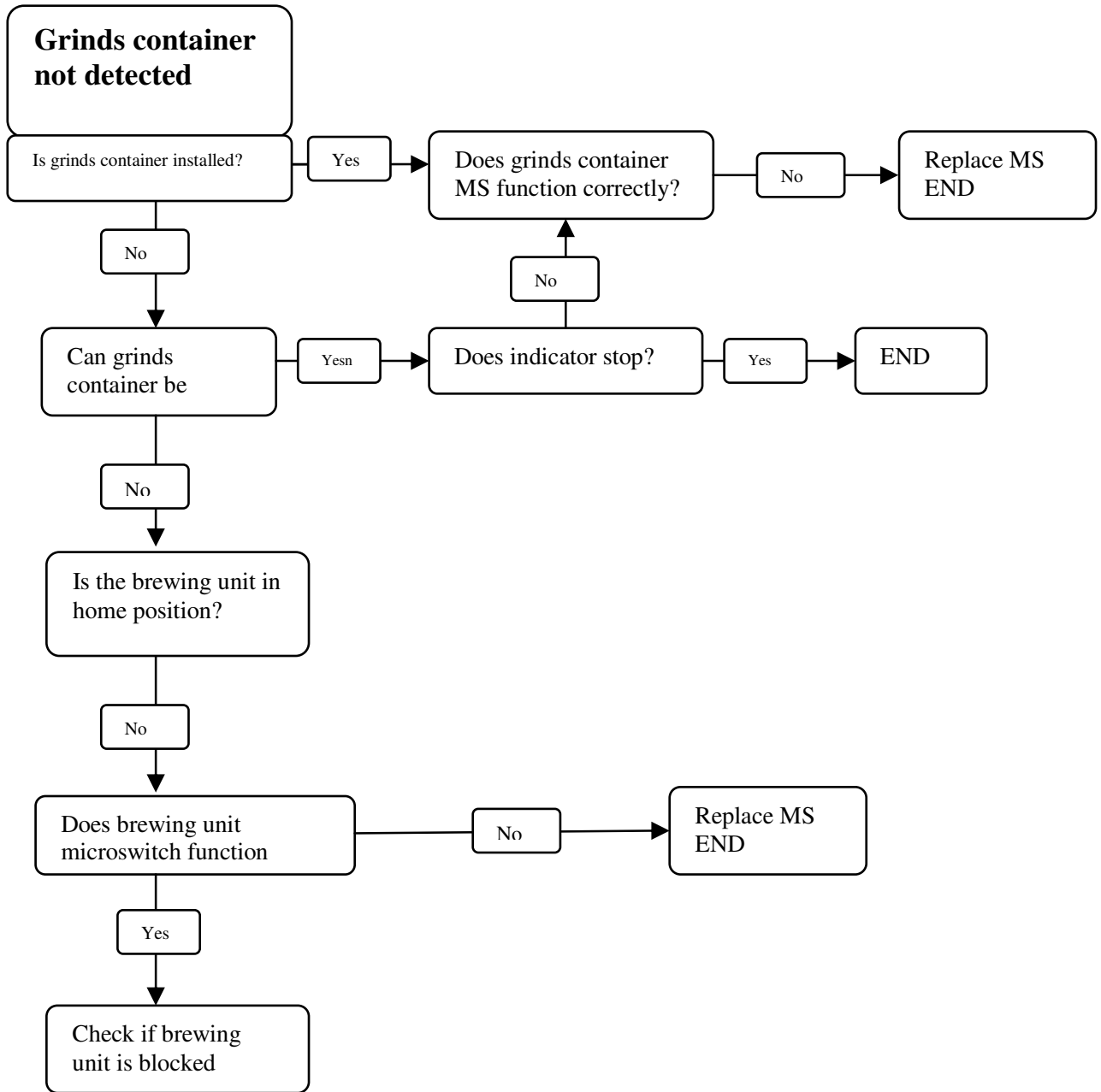

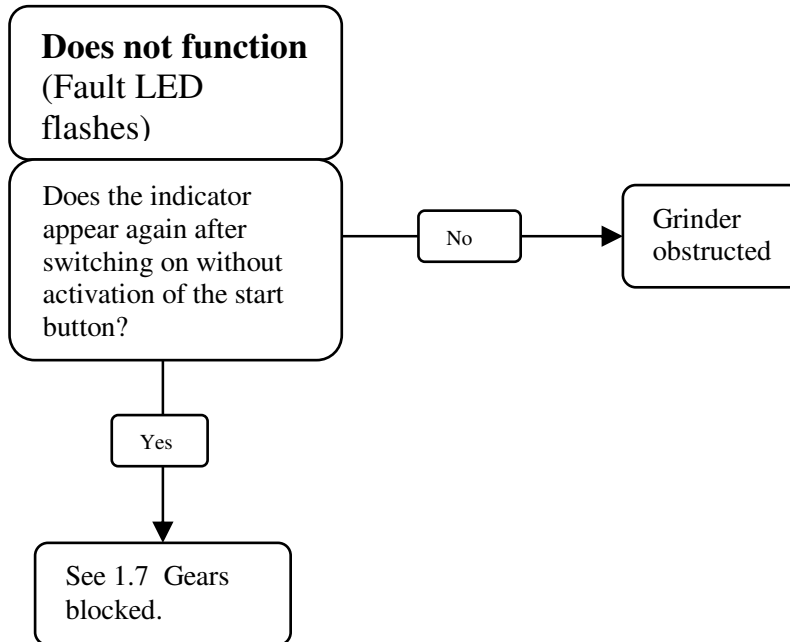
1.6. Machine does not function (red LED flashes)

1.7. Brewing unit blocked / Gears blocked

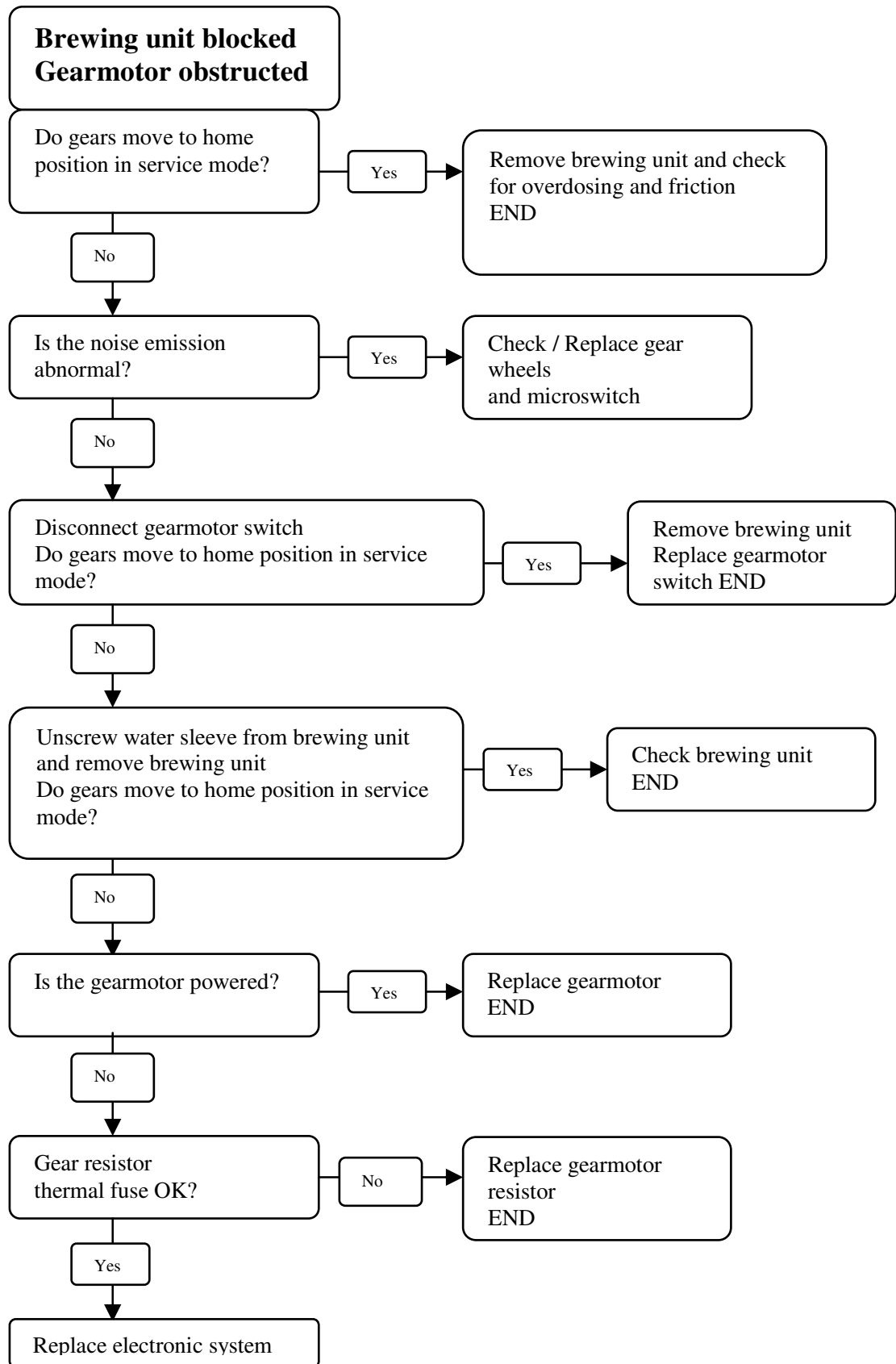

CHAPTER 8

REPAIRS /

SERVICE SCHEDULE

	Page
1. Repairs schedule	1
2. Service schedule	1
3. Final test	2

1. Repairs schedule:

The repairs schedule, together with the service schedule, lists all relevant activities to be performed in an efficient sequence.

	Activity
1	Visual check (transport damage)
2	Record of machine data
3	Functional check / Error analysis (test mode)
4	Opening of machine
5	Visual check (leakages)
6	Mechanical systems check (functional test)
7	Defect detection
8	Modifications check
9	Service operations according to service schedule
10	Internal cleaning
11	Functional test (with open machine / leakage test)
12	Assembly
13	Final test according to test schedule
14	Steam off (in the event of risk of frost)
15	External cleaning
16	Lubrication of brewing unit
17	Insulation test
18	Documentation

2. Service schedule:

Service activities

R = Replace

C = Clean

VC = Visual check

AT = Acoustic test

D = Descale

A = Adjustment

Component	Activity	Equipment
Water filter	R	
Lip seal / Water tank	R	
Coffee return flow valve	R	
Valve spring	R	
Valve plug O-ring	R	
Valve plug O-ring	R	
Filter (brewing unit)	C / VC	Grease solvent
Hose connections	VC	
Pump	VC / AT	
Gearmotor	AT / VC	
Grinder	C / A	Vacuum cleaner / brush
Doser	C	Vacuum cleaner / brush
Water circuit	D	Descaler (Saeco)
HWS valve	VC / R	
Water outlet (valve plug)	C	Grease solvent / brush
O-ring (boiler connection / instantaneous water heater)	R	

3. Final test:

Test	Procedure	Equipment	Instruction	Tolerance
Cup fill volume	2-3 cups on espresso setting	Measuring beaker	Equal quantity	15%
Cup fill volume	2-3 cups on coffee setting	Measuring beaker	Equal quantity	15%
Noise emission			Empirical value Standard noise	
Froth quantity	Carefully froth coffee in cup until froth separates		Froth cover must subsequently close completely	
Colour of froth			Textured light brown	
Temperature	Measurement of dispensed coffee stream	Temperature - measuring device	84 °C	± 4 °C
Grind level	Check grain size of coffee grinds		See Training	
Hot water	Dispense hot water			
Steam function	Dispense steam			
Water Low indicator	Remove tank		Fill water tank indicator	
Grinds Container Absent indicator	Remove grinds container		Grinds Container Absent indicator	
Coffee Beans Low indicator	Start coffee programme - coffee bean container empty		Coffee Beans Low indicator	
Insulation test			HG 701	

CHAPTER 9

DISASSEMBLY

	Page
1. Disassembly of the housing	1
2. Disassembling the electronic system	4
3. Disassembling the doser	5
4. Disassembling doser switch fitting	7
5. Disassembling HWD pipe	8
6. Disassembling HWD valve	10
7. Disassembling the grinder	12
8. Disassembling the grinder motor	16
9. Adjusting the grinder	18
10. Disassemble the instantaneous water heater	21
11. Disassembling the gears	24
12. Disassembling the pump	27

1. Disassembly of the housing

- a) Remove the water tank and the coffee bean container cover.
- b) Remove the three fixing screws (1) of the coffee bean container.
- c) Remove the three fixing screws (2) of the powder compartment.
- d) Remove the two fixing screws (3) of the front operating panel.

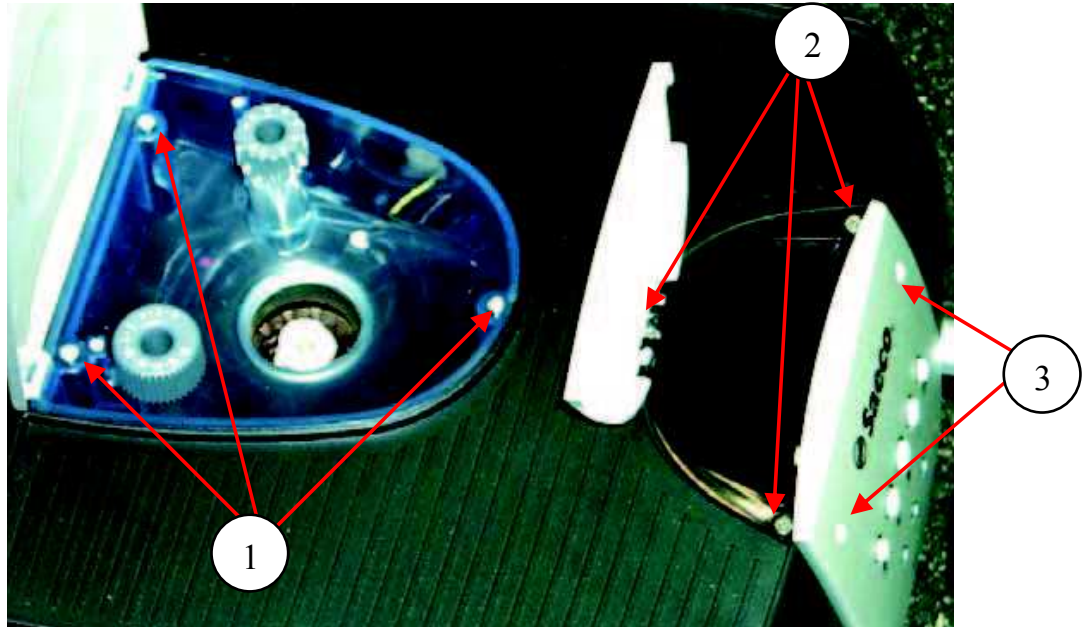

Fig. 1

- e) Remove the rear housing screws (1).

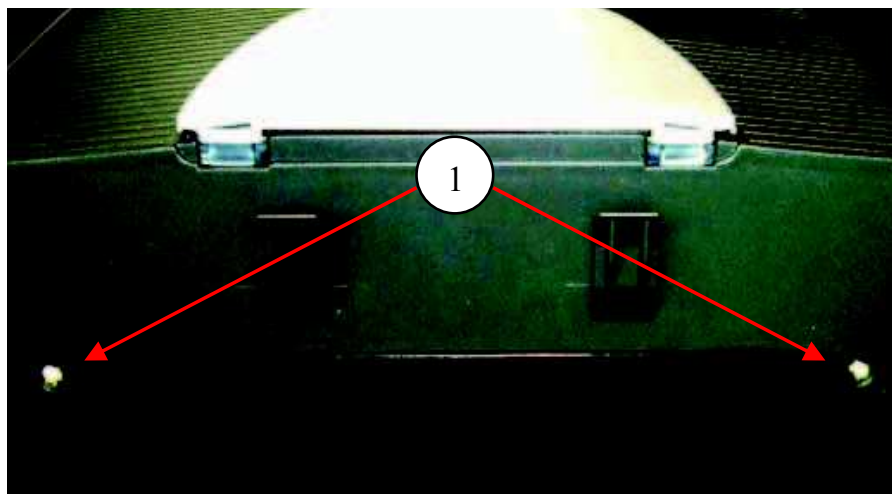

Fig. 2

- f) Remove the two bottom housing screws (1).

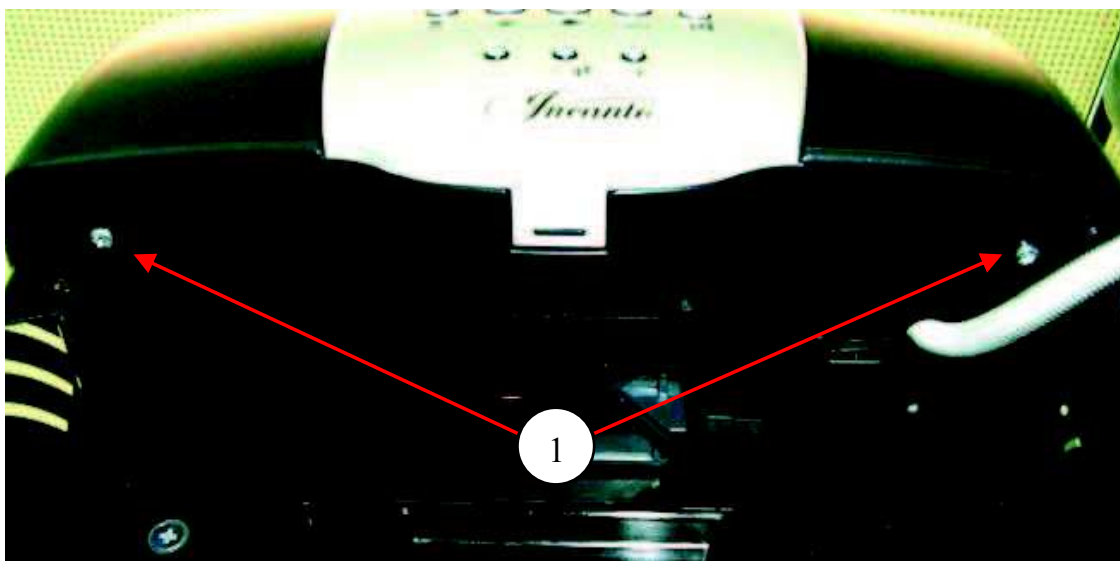

Fig. 3

- g) Turn steam dial to the right (1) and remove the housing by pulling upwards.

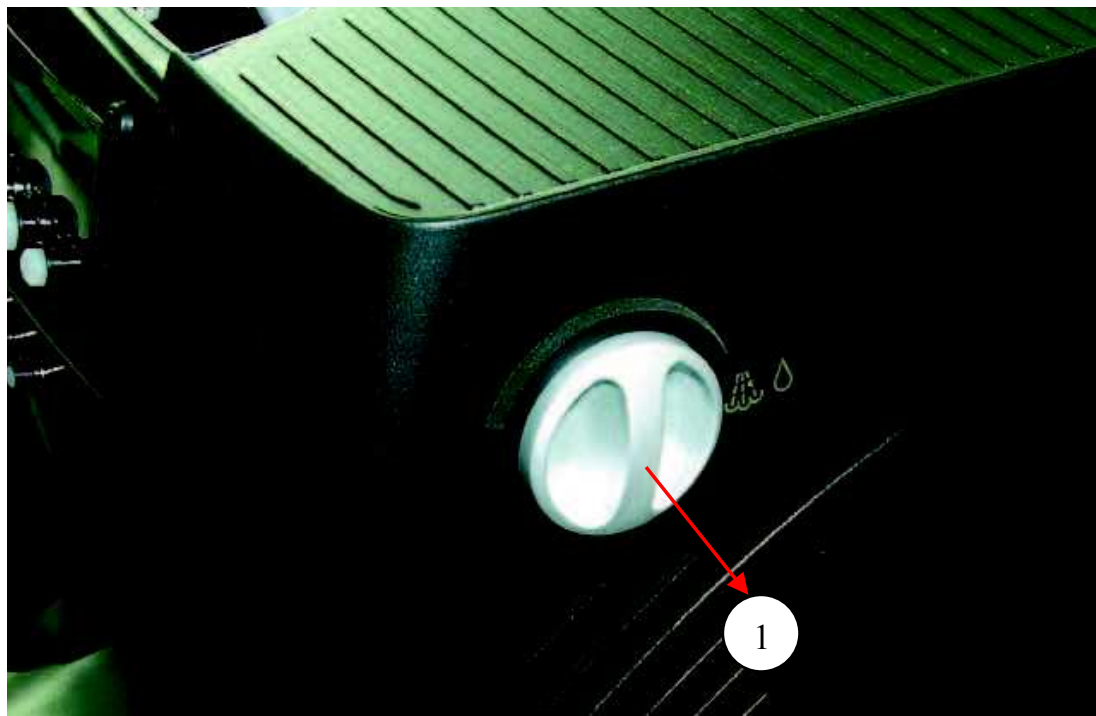

Fig. 4

- h) Tilt the machine panel backwards, remove the reed sensor fixing screw (1) and remove the water hose (2).

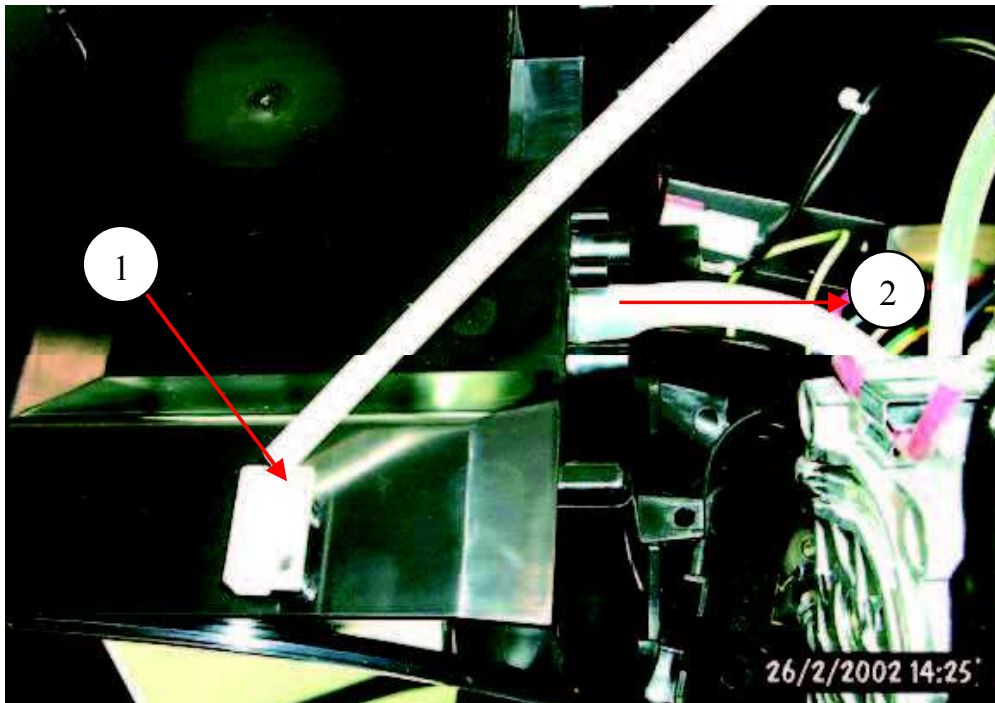

Fig. 5

2. Disassembling the electronic system

- a) Unscrew the two fixing screws of the electronic system fitting and tilt the electronic system backwards.

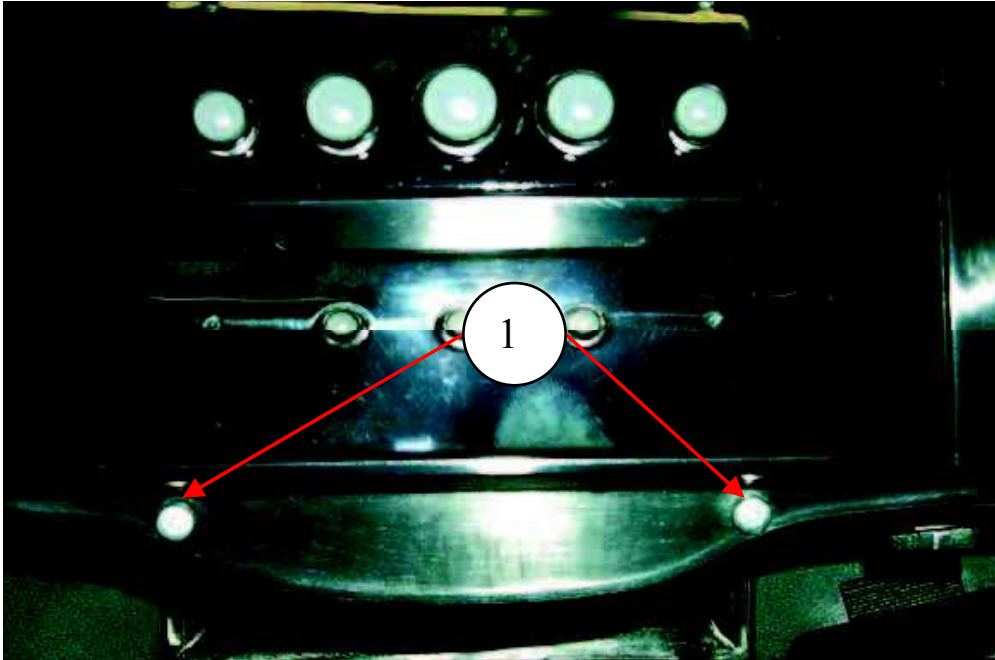

Fig. 6

- b) Remove the four fixing screws (2) and carefully remove the electronic system (follow the same procedure for the control panel).

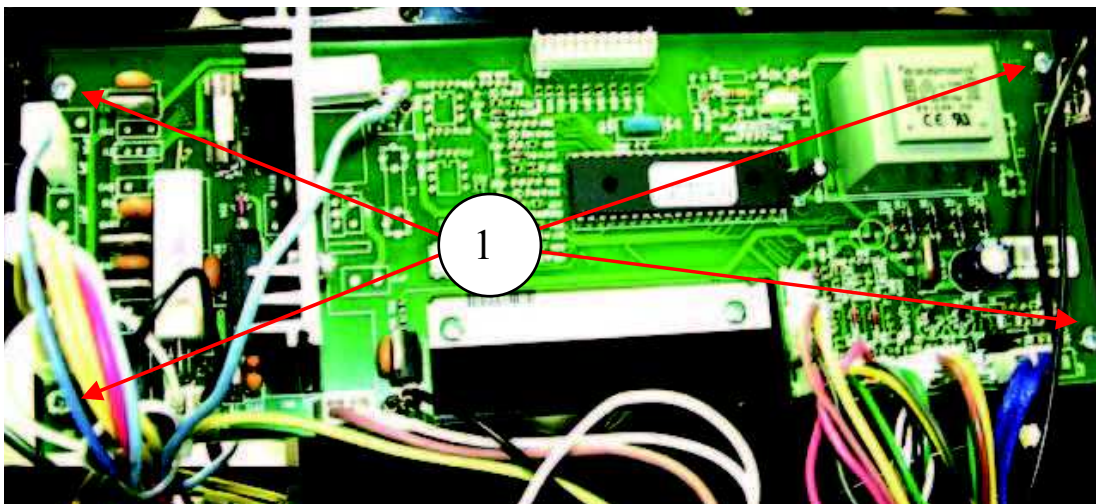

Fig. 7

3. Disassembling the doser

- a) Release the tab (1) by using a screw driver and push dosing magnet out of its fitting (2).

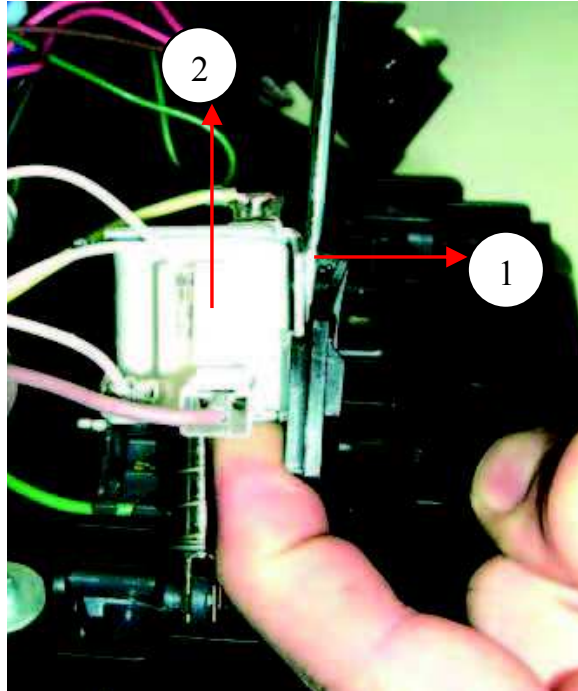

Fig. 8

- b) Unscrew the two fixing screws and remove cover.

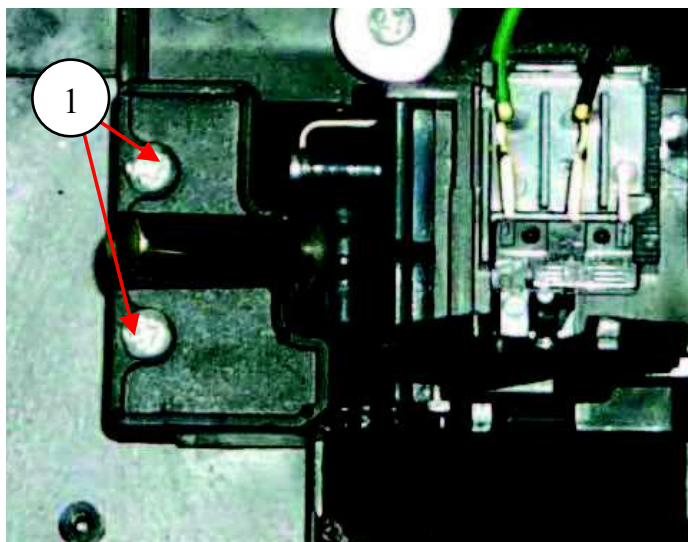

Fig. 9

- c) Using a screwdriver, first push the doser flap valve out of the open bearing seat (1). Then perform the same action on the opposite side (2).

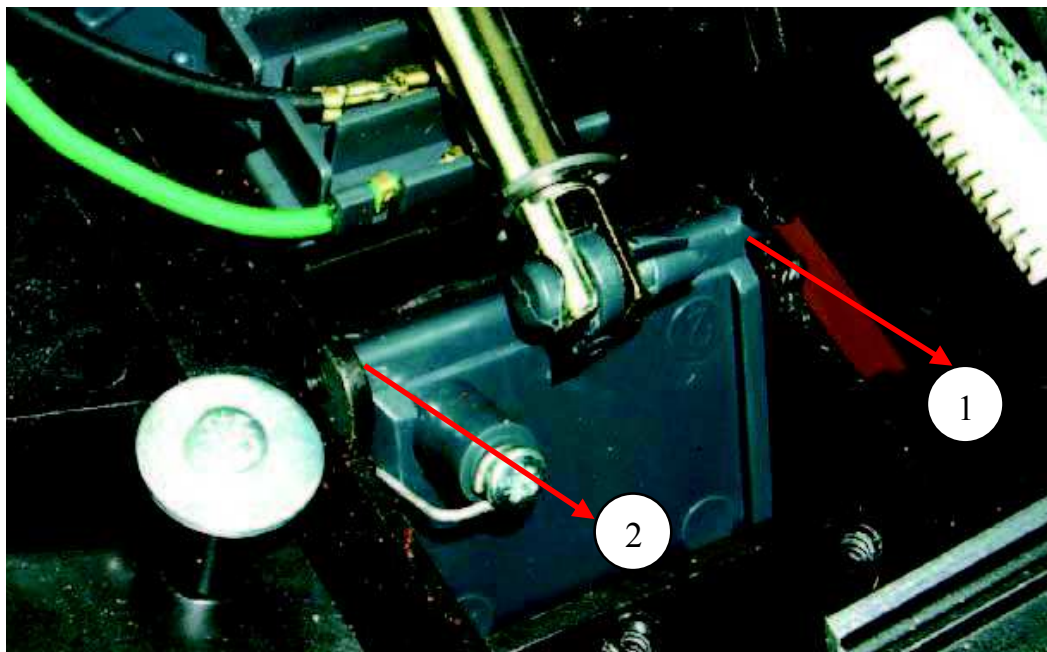

Fig. 10

4. Disassembling doser switch fitting

- a) Disassemble housing.
- b) Disassemble doser switch.
- c) Push doser switch from its fitting (1).
- d) Lift dosing lever from its fitting (2) and push doser switch fitting forward out of the guide (3).

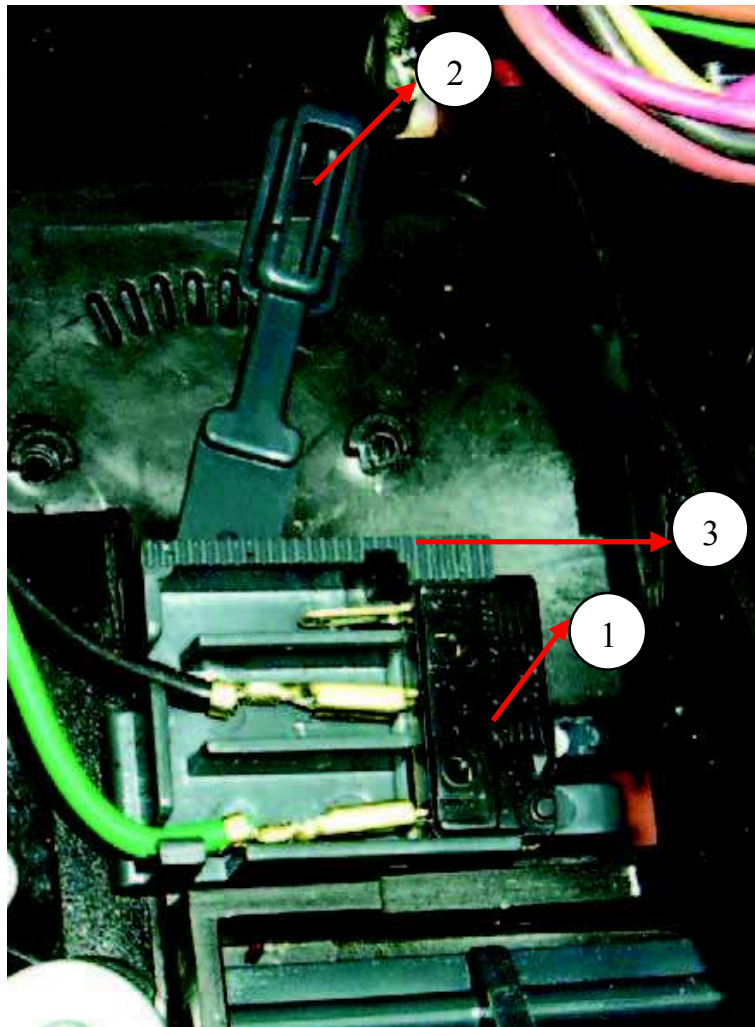

Fig. 11

5. Disassembling HWD pipe

- a) Remove clip spring (1) from the HWD pipe.

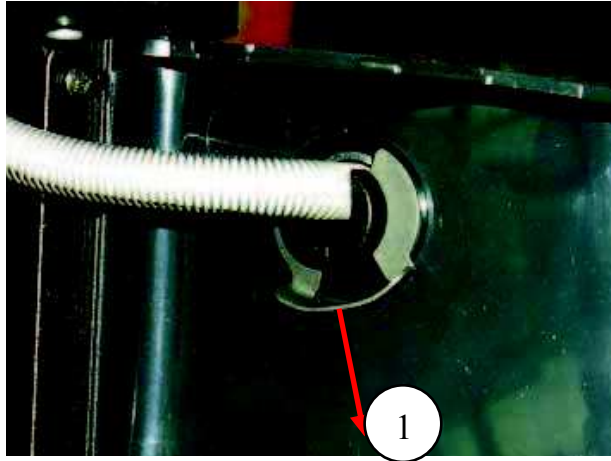

Fig. 12

- b) Unscrew locking screw from milk frothing nozzle and remove frothing nozzle from HWD pipe (1).
c) Remove HWD pipe cover (2).

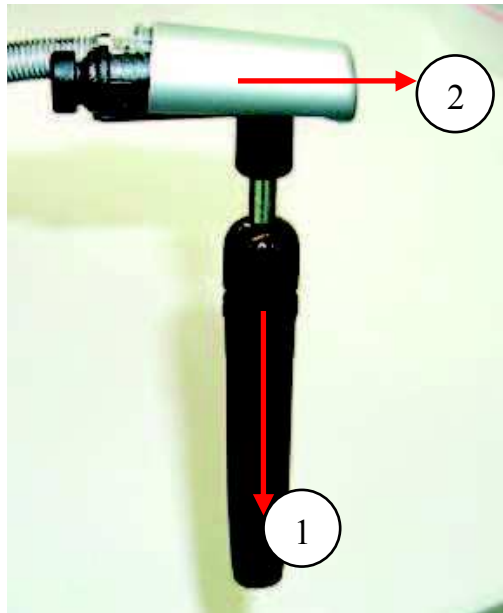

Fig. 13

- d) Remove HWD pipe fitting (1) and feed HWD pipe through door.

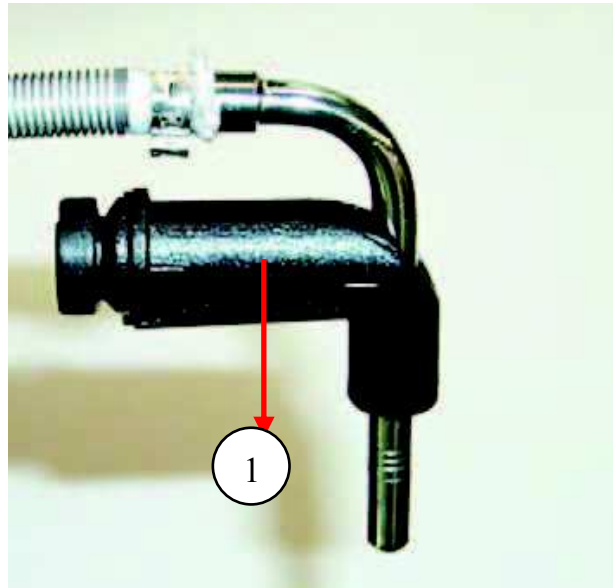

Fig. 16

6. Disassembling HWD valve

- a) Unscrew fixing spring from hose connection (1) and remove hose.

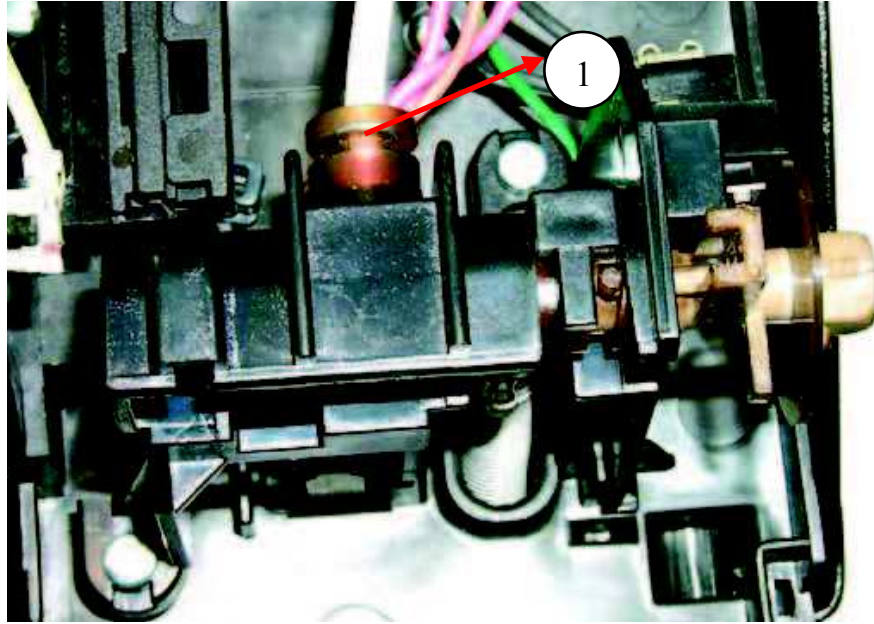

Fig. 15

- b) Push valve housing from its fitting (1).
c) Release the fastening tab from the HWD spout (2) and pull spout from its housing (3).
d) Remove fixing spring (4).

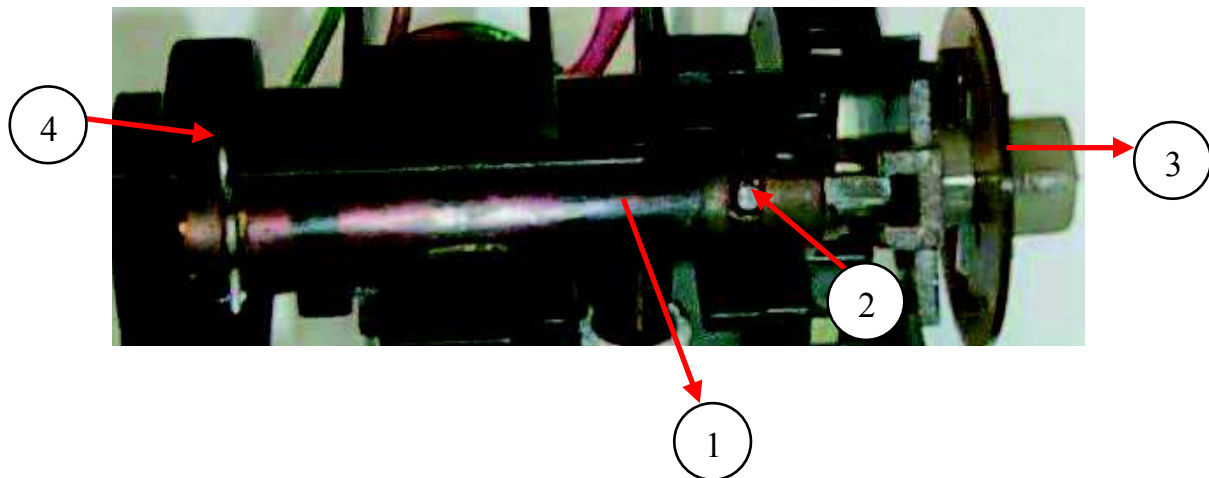

Fig. 16

e) Remove valve components from housing.



Fig. 17

7. Disassembling the grinder

- a) Disassemble housing.
- b) Remove the tooth rack for adjusting the dosage by unscrewing the three fixing screws (1).



Fig. 18

- c) Remove the fixing screw of the upper grinding adjustment ring (1).

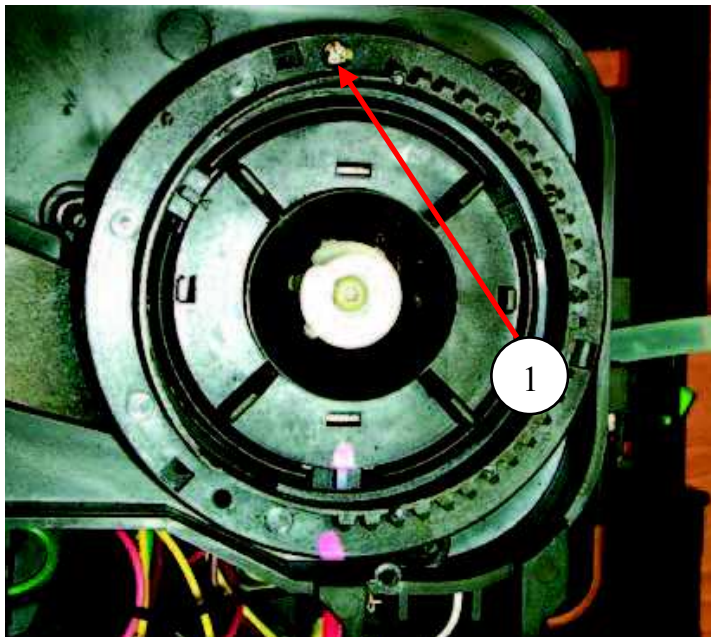

Fig. 19

- d) Release the three fastening tabs (1) on the underside and remove the upper grinding adjustment ring (2).

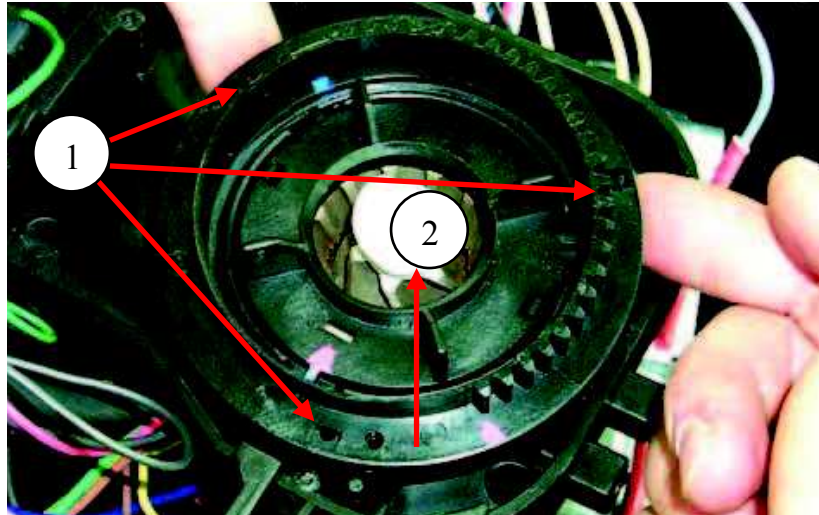

Fig. 20

- e) Turn the grinding adjustment ring (1) clockwise until the three lugs of the grinding disc fitting (2) are clearly visible and remove the upper grinding disc from the grinder.

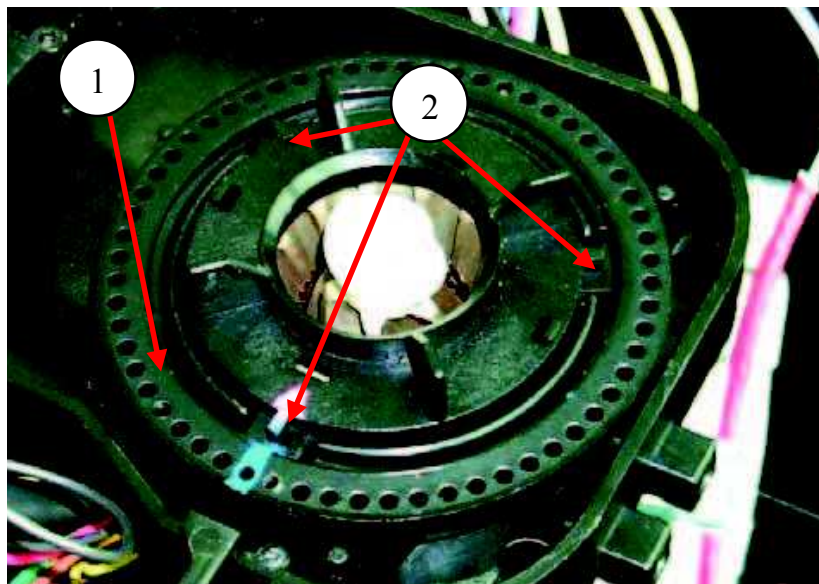

Fig. 21

- f) Remove the fixing screw (1) of the grinding cone (note: left thread) and carefully remove the grinding cone (gravel protection).

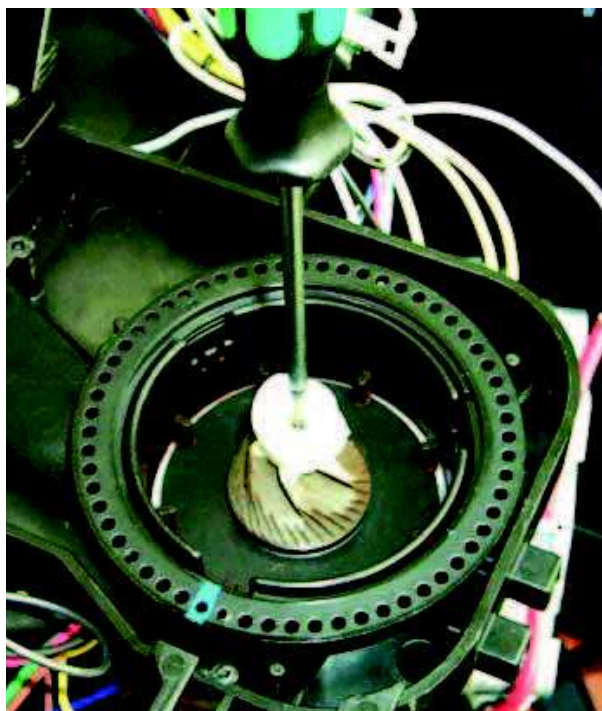

Fig. 22

- g) Carefully remove the clutch disc (1).

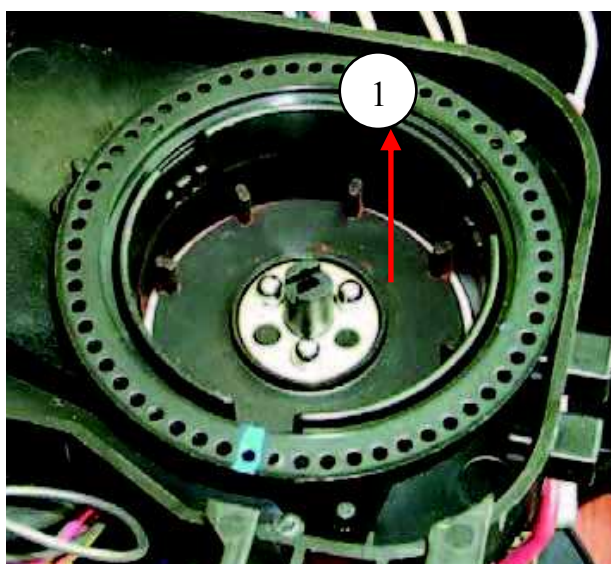

Fig. 23

h) The sealing felt can then be cleaned (1).

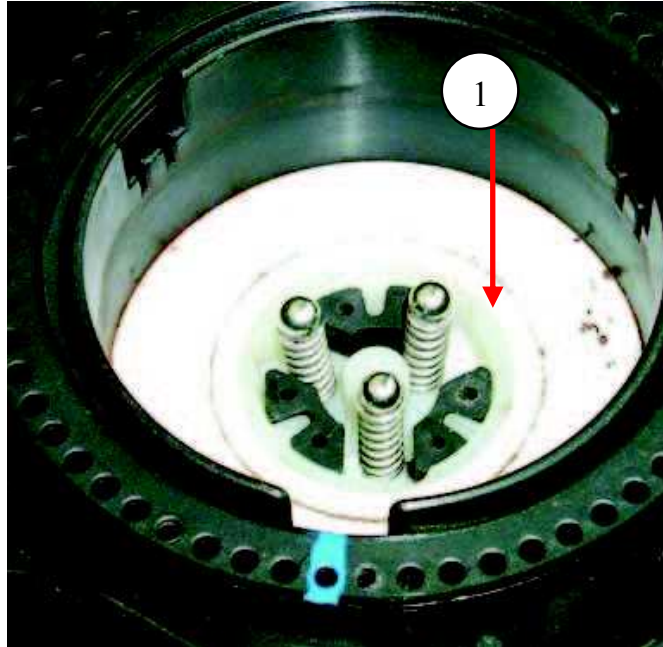

Fig. 24

8. Disassembling the grinder motor

- a) Disassemble housing.
- b) Disassembling the grinder
- c) Remove the fixing screw of the coffee duct (1).

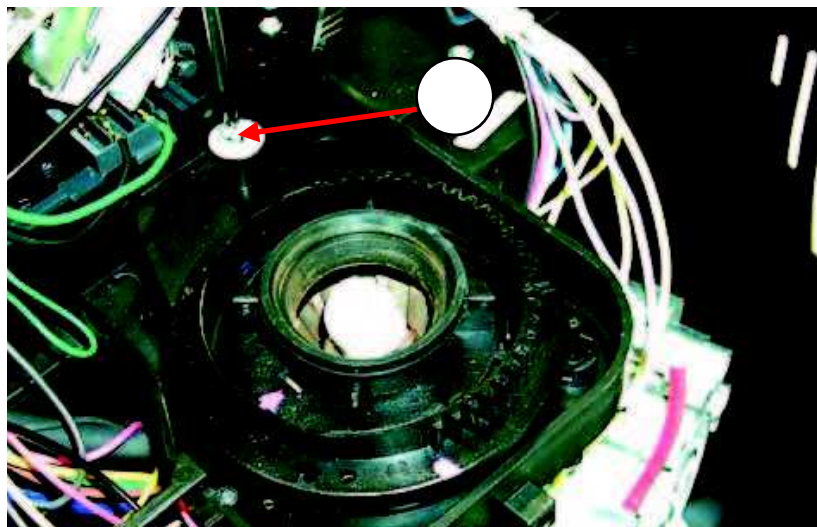

Fig. 25

- d) Pull the grinder from its fitting (1).

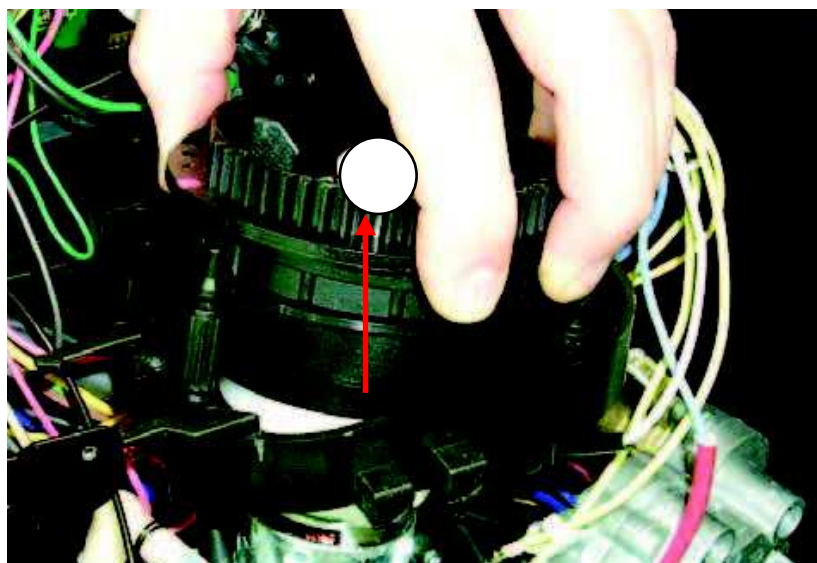

Fig. 26

- e) Remove safety ring (1) and release the three radially positioned tabs (2). Remove the motor with gears from grinder housing (3).

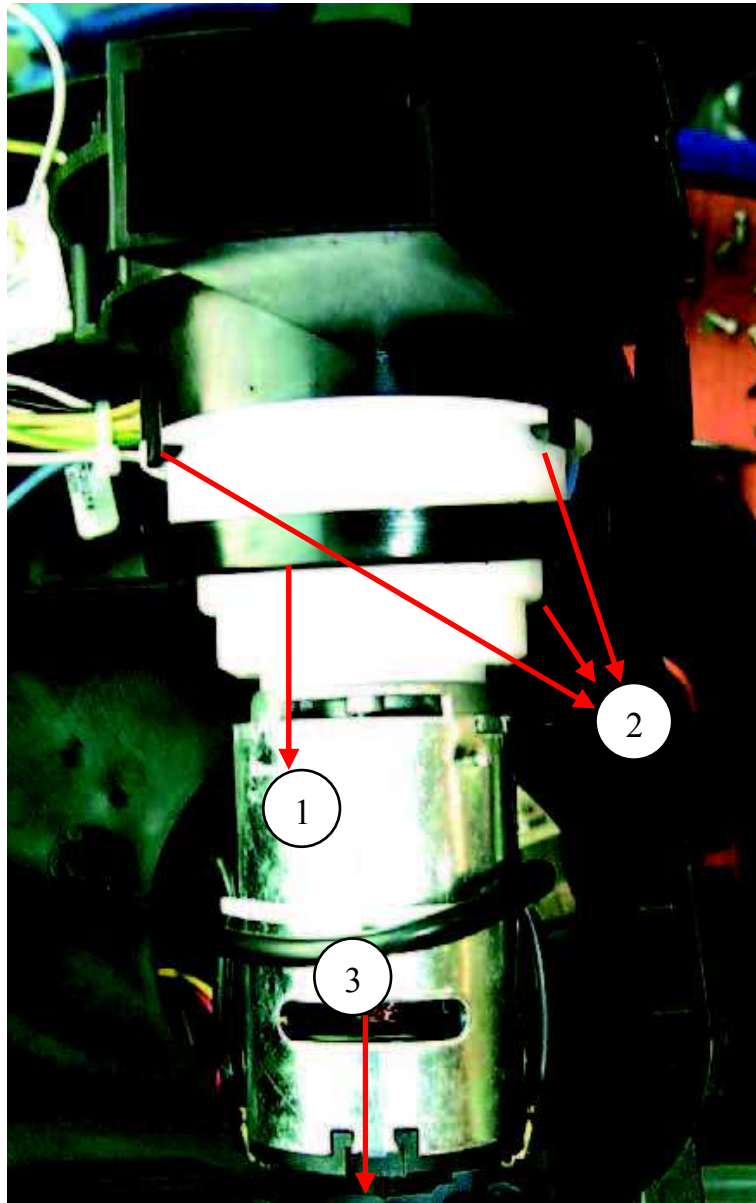

Fig. 27

9. Adjusting the grinder

- a) Install the grinding ring onto its fitting so that the marking (1) on the grinding adjustment ring and the ring fitting (2) are adjacent to one another.

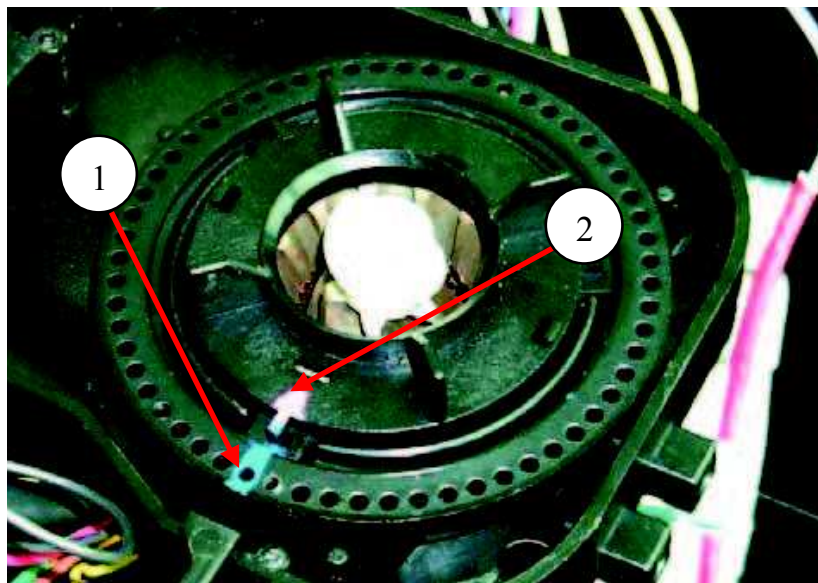

Fig. 28

- b) Turn the grinding adjustment ring clockwise until a certain friction can be felt.



Fig. 29

- c) Turn about 14 notches in an anti-clockwise direction.
- d) Make several test coffees and determine the basic setting depending on froth, flow rate and dregs grain size.

ATTENTION: Changes to the grind level take effect after about three grinding cycles following adjustments to the coffee process.

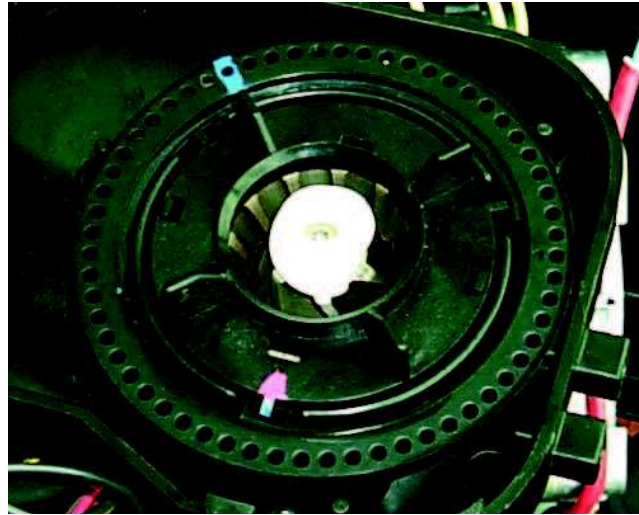

Fig. 30

- e) Place the upper grinding adjustment ring with the red mark as indicated (1) and screw the fixing and locking screw in the appropriate position (2).

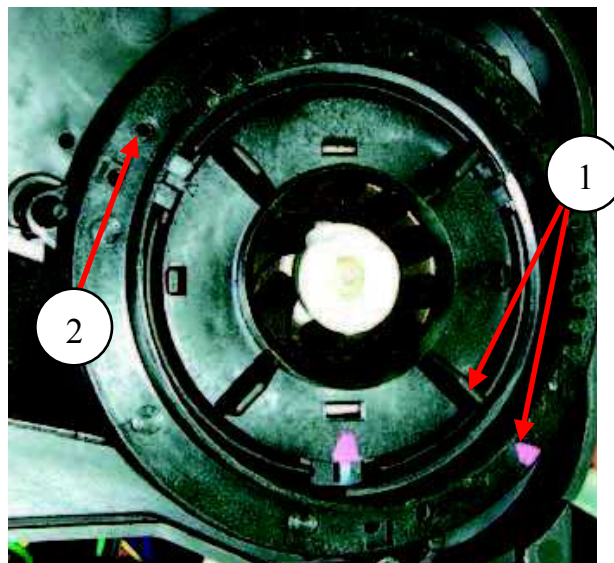

Fig. 31

- f) When installing the coffee bean container, ensure that the dosage adjustor is in position 8.

10. Disassembling the instantaneous water heater

- a) Remove thermal fuse fitting (1).
- b) Remove the two connector plugs (2) of the gear resistor.
- c) Remove the two connector plugs of the main heating element (3).

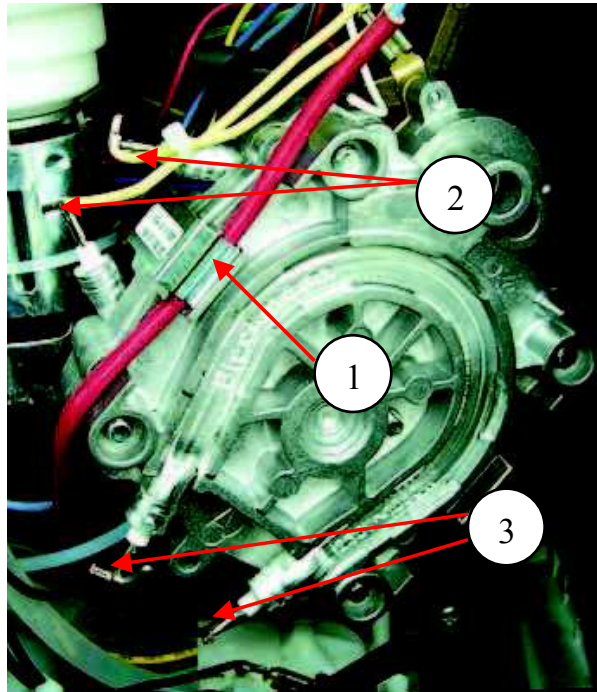

Fig. 32

Remove the three fixing screws of the instantaneous water heater (1).

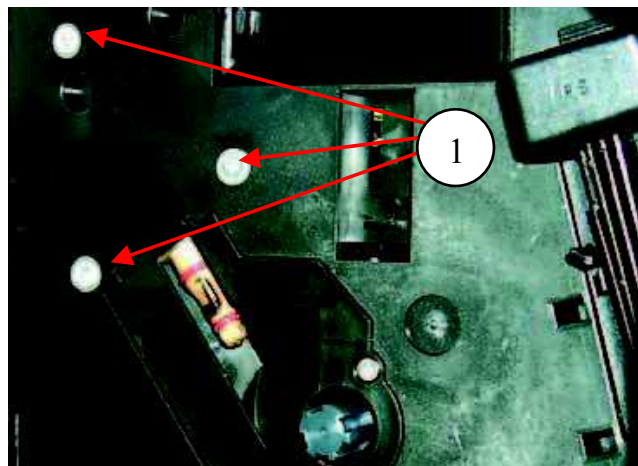

Fig. 33

- d) Remove the two hose clips (1) and pull hoses off connection angle (have a container available for catching the water).
- e) Disconnect earth connection (2).

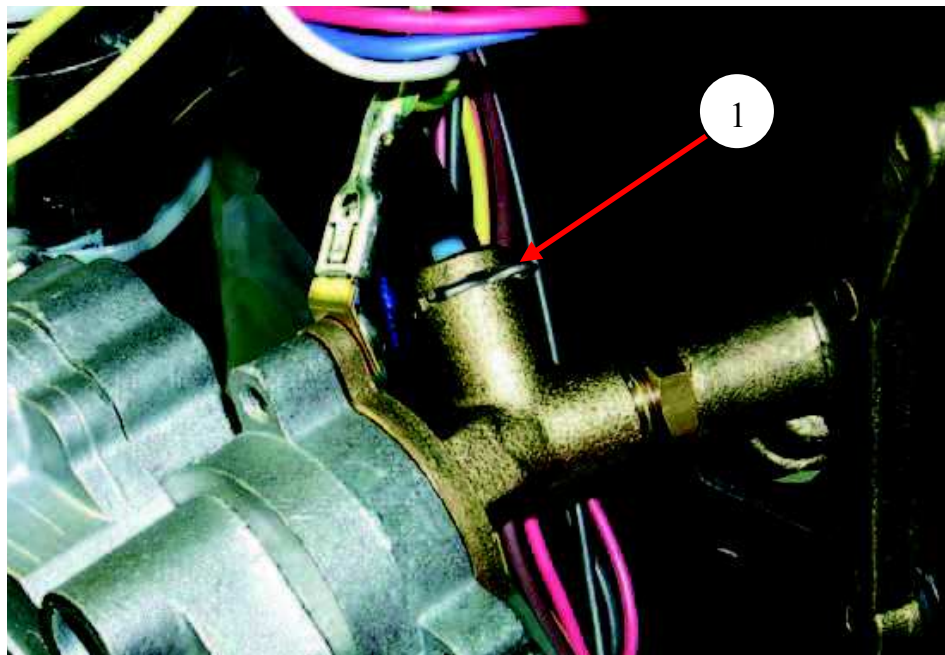

Fig. 34

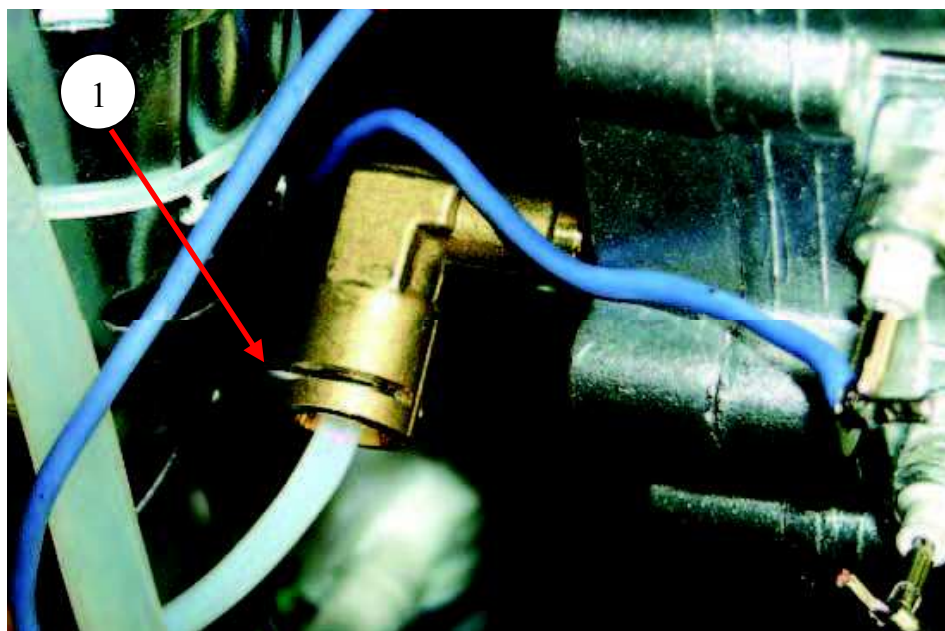

Fig. 35

- f) Uninstall thermostat spring, and remove thermal sensor (KTY) and thermostat (1).
- g) Unscrew the three screws and dismantle valve body support (2).

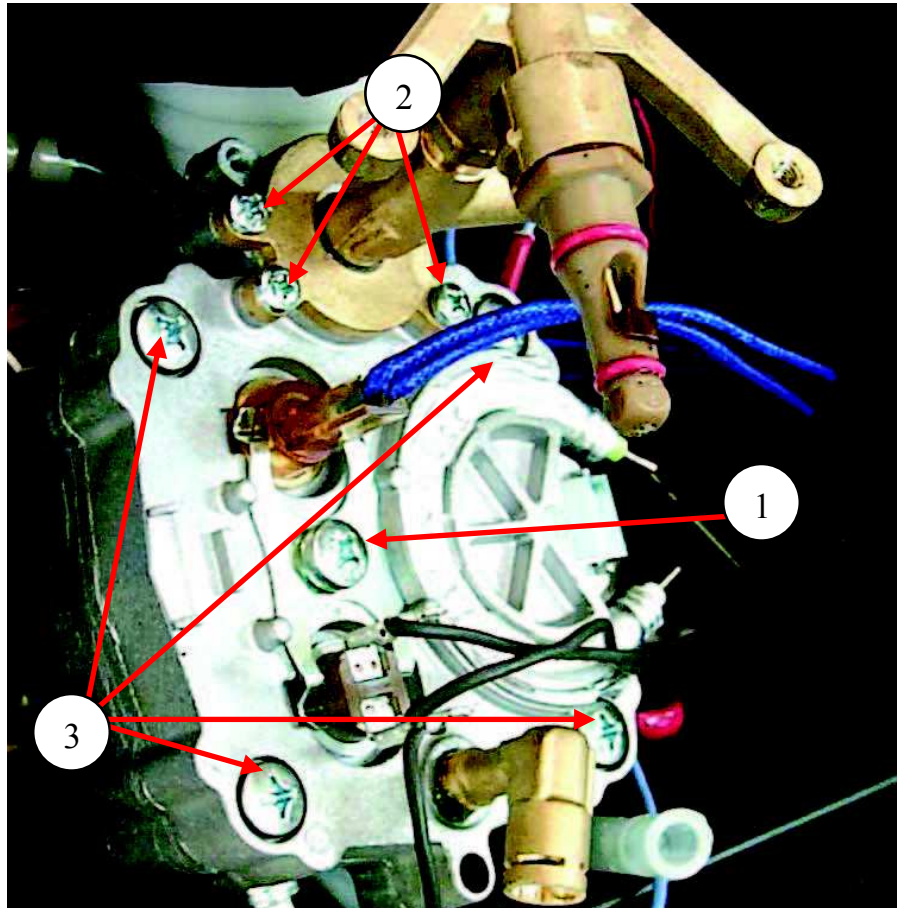

Fig. 36

Comments: The four screws of the instantaneous water heater (3) must be reused in the new instantaneous water heater.

ATTENTION: In the event that the KTY is replaced, the old metal core must be reused in the new KTY.

11. Disassembling the gears

- a) Disassemble housing.
- b) Disassemble base plate: Unscrew the upper (1) and lower (2) fixing screw, remove housing earthing and mounting plate from the housing.
- c) Release instantaneous water heater (3).

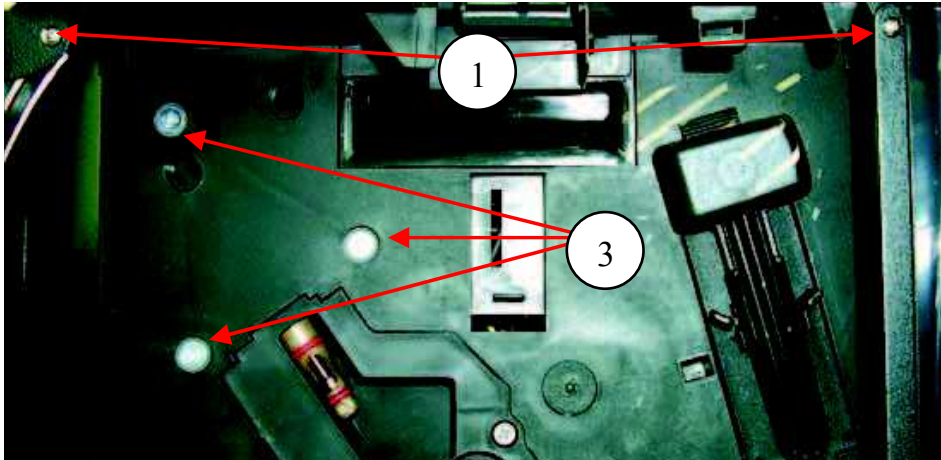

Fig. 37

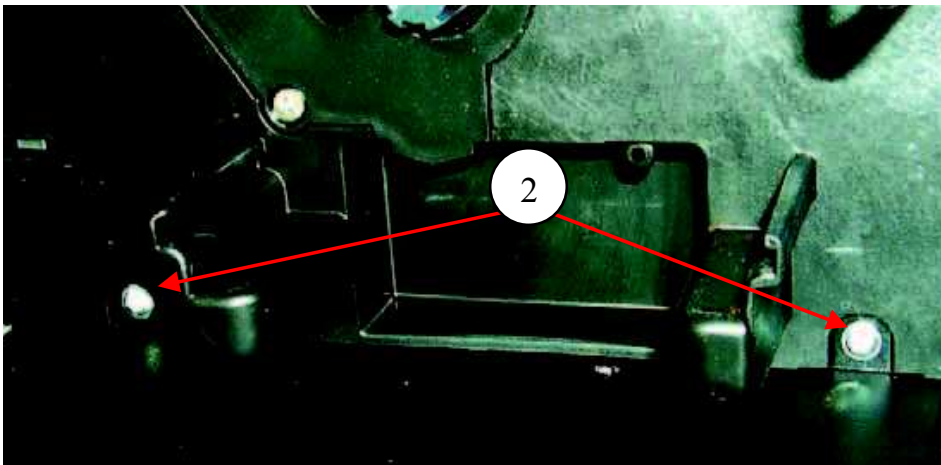

Fig. 38

- d) Remove instantaneous water heater feed line (see Fig. 34 & 35).
- e) Pull grinding motor out of its fitting (see Fig. 26).

- f) Unscrew the nine screws (1) of the gear cover and remove cover.

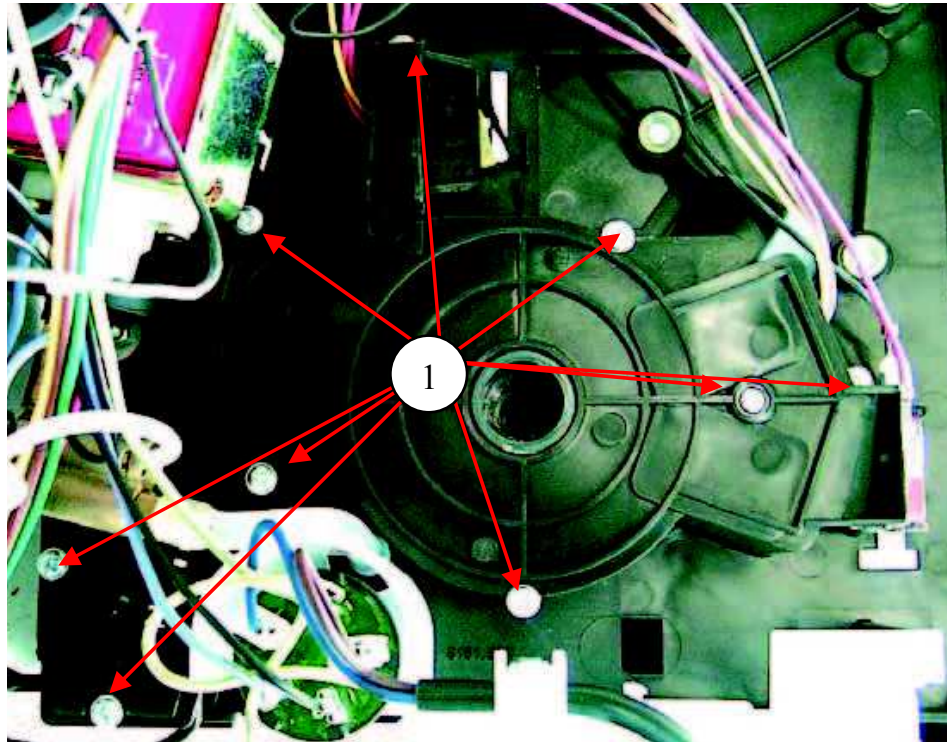

Fig. 39

When replacing the gear wheels, the arrow on the large gear wheel (1) must face in the direction of the axis of the small gear wheel (2). The brewing unit cannot be installed in this position (Install all components, switch on machine - gears go to home position - install brewing unit.) The small gear wheel can be assembled as required.

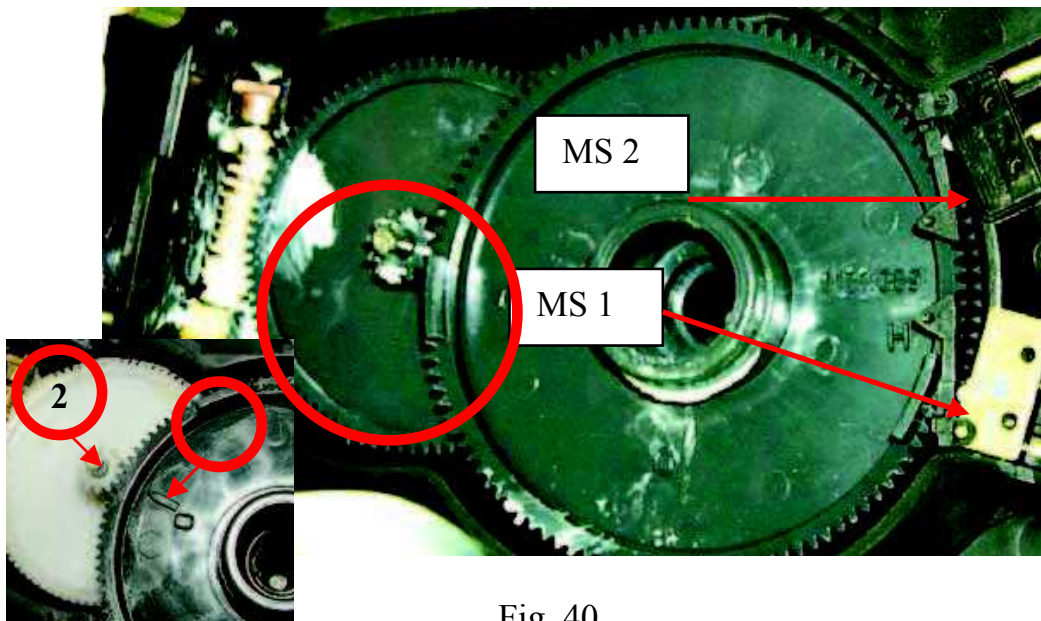

Fig. 40

The gear motor can be removed without dismantling the pump (1).

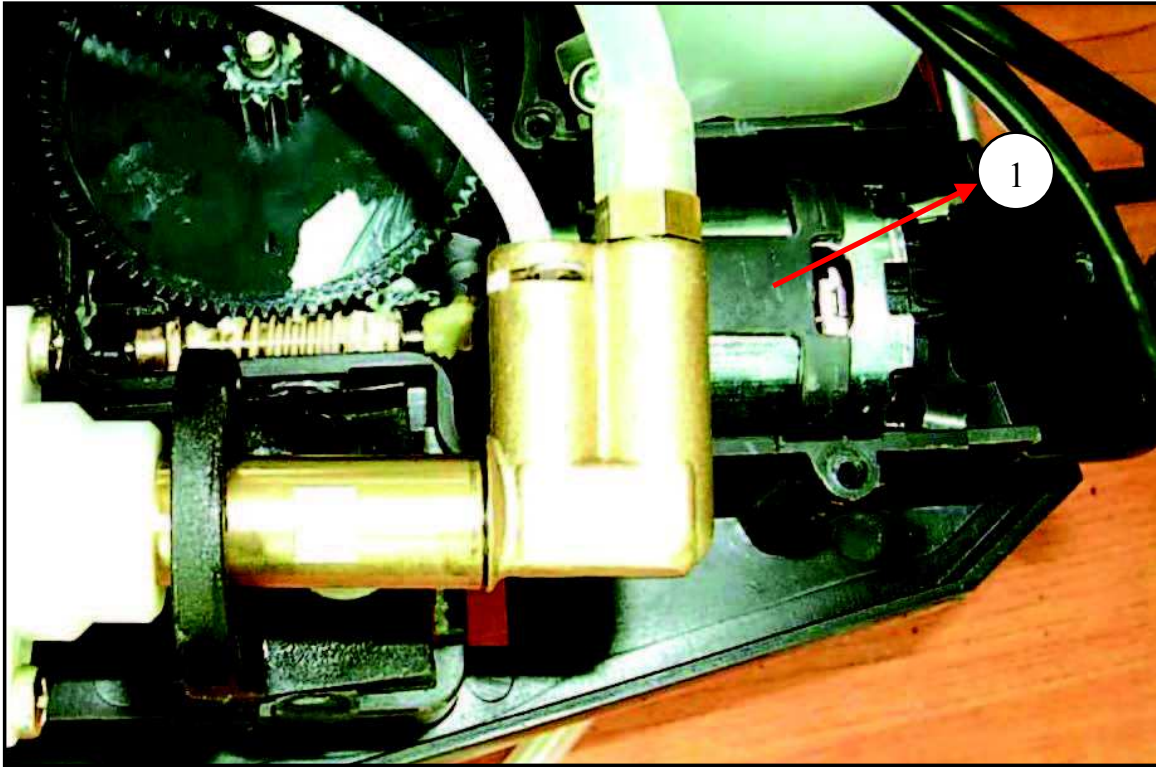

Fig. 41

12. Disassembling the pump

- a) Disassemble housing.
- b) Remove powder coffee measuring jug (1).
- c) Release (2) cover and remove (3).

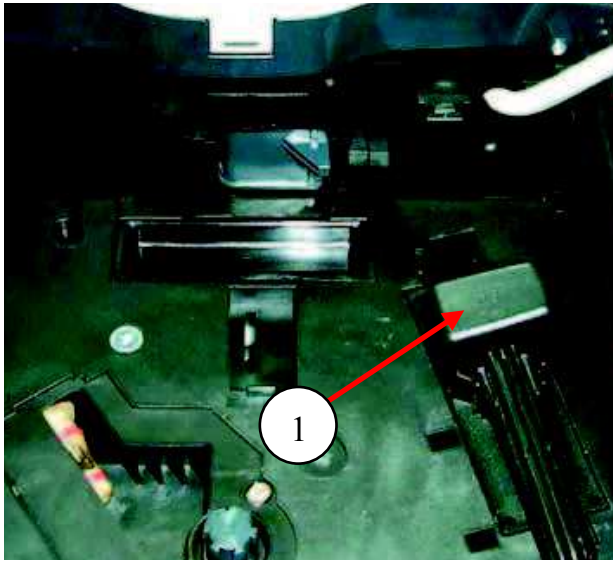

Fig. 42

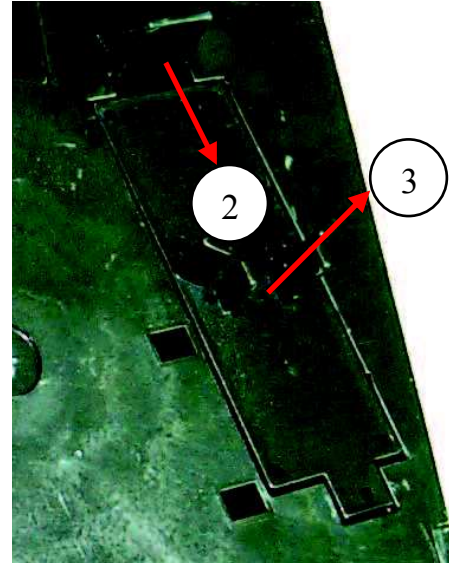

Fig. 43

- d) Release the four fastening tabs (1) and remove the pump assembly bracket protection (2).

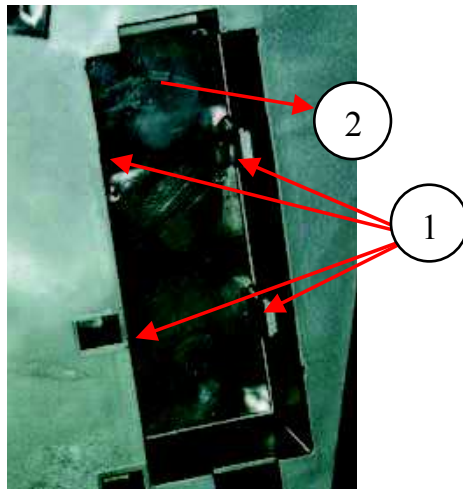

Fig. 44



Fig. 45

- e) Remove upper pump connection angle (1) and overpressure hose (2).
- f) Remove fixing spring (3) and pressure hose (4).

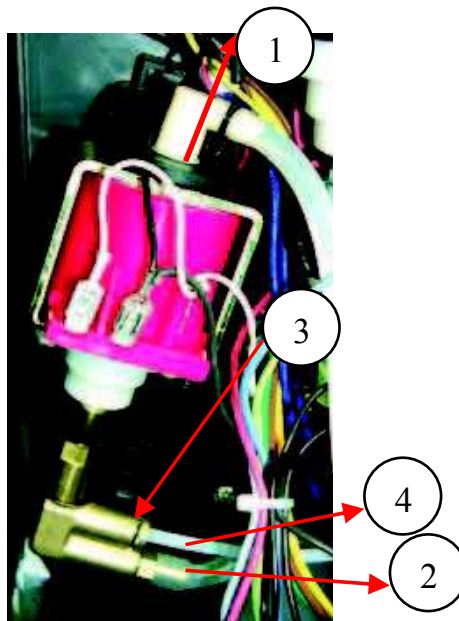

Fig. 46

- g) Disconnect upper pump from retainer (1).
- h) Release lower pump retainer by pushing upwards (2).

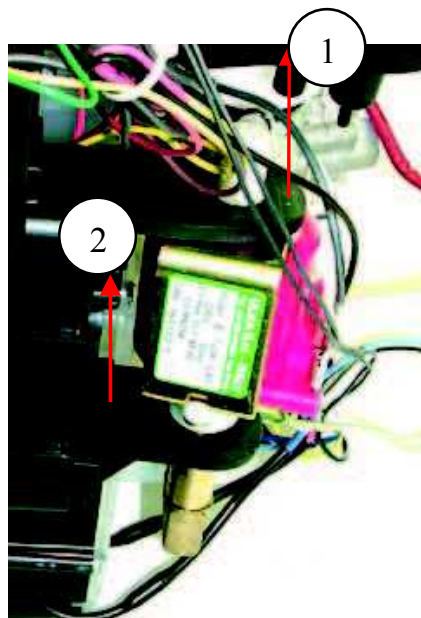

Fig. 47

CHAPTER 10

CIRCUIT DIAGRAMS

